



SP2354

1A Buck-Boost LED Driver

DESCRIPTION

The SP2354 is a high efficiency synchronous buck/boost DC/DC converter for application using battery powered devices to drive a single power LED at current up to 1A. The regulator operates in either synchronous buck, boost or buck-boost mode depending on the input voltage and LED forward voltage. Efficiency greater than 90% can be achieved over the entire usable range of Li-Ion battery: 2.8V to 5.5V.

LED current is programmable to one of four levels, including shutdown, with dual external resistors and dual enable inputs. In shutdown no supply current is drawn.

A high operation frequency of 1MHz allows using of small external components. The SP2354 is offered in DFN10 package.

FEATURES

- Higher than 85% Efficiency
- Wide Input Voltage Range: 2.8V to 5.5V
- Faulty LED Protection
- Internal Soft Start
- Up to 1A continuous Output Current
- Zero Shutdown Current
- Over Temperature Protection
- Over Current Protection
- Constant Frequency 1.0MHz Operation
- DFN10 Package

APPLICATIONS

- Digital Camera
- PDA
- Hand Held Communication Equipment
- Li-Ion LED Driver
- Cell Phone Camera Flash
- Cell Phone Torch Lighting

PIN CONFIGURATION (DFN-10)

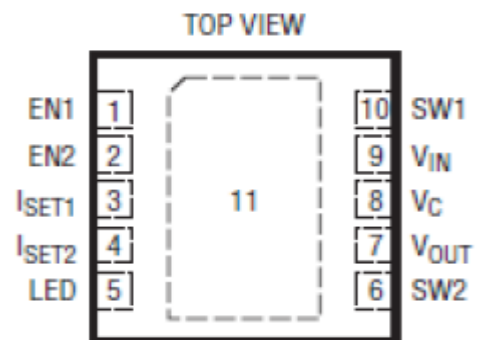

PART MARKING

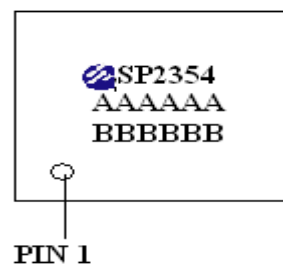

AAAAAA : Wafer lot no.
BBBBBB : YYMMDD



SP2354

1A Buck-Boost LED Driver

TYPICAL APPLICATION CIRCUIT

EN2	EN1	LED current
0	0	0 (oFF)
0	1	175mA
1	0	825mA
1	1	1A

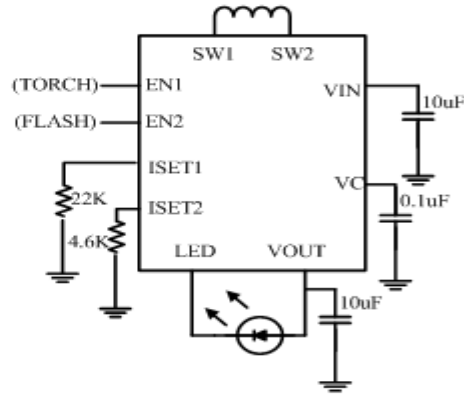

PIN DESCRIPTION & ELECTRICAL CHARACTERISTICS

Pin	Symbol	Description	Operating Rating			
			Min.	Typ.	Max.	Unit
1	EN1	Enable Input for ISET1	-0.3		V _{IN} +0.3	V
2	EN2	Enable Input for ISET2	-0.3		V _{IN} +0.3	V
3	ISET1	LED Current Program 1	-0.3		V _{IN} +0.3	V
4	ISET2	LED Current Program 2	-0.3		V _{IN} +0.3	V
5	LED	Output for LED Current Biasing			1	A
6	SW2	Switching Node 1	-0.3		6	V
7	V _{OUT}	Buck-Boost Output	-0.3		6	V
8	V _C	Compensation Point for Internal Error Amplifier	-0.3		V _{IN} +0.3	V
9	V _{IN}	Supply Voltage	-0.3		6	
10	SW1	Switching Node 2	-0.3		6	
11	GND	Ground, Exposed Pad				



SP2354

1A Buck-Boost LED Driver

BLOCK DIAGRAM

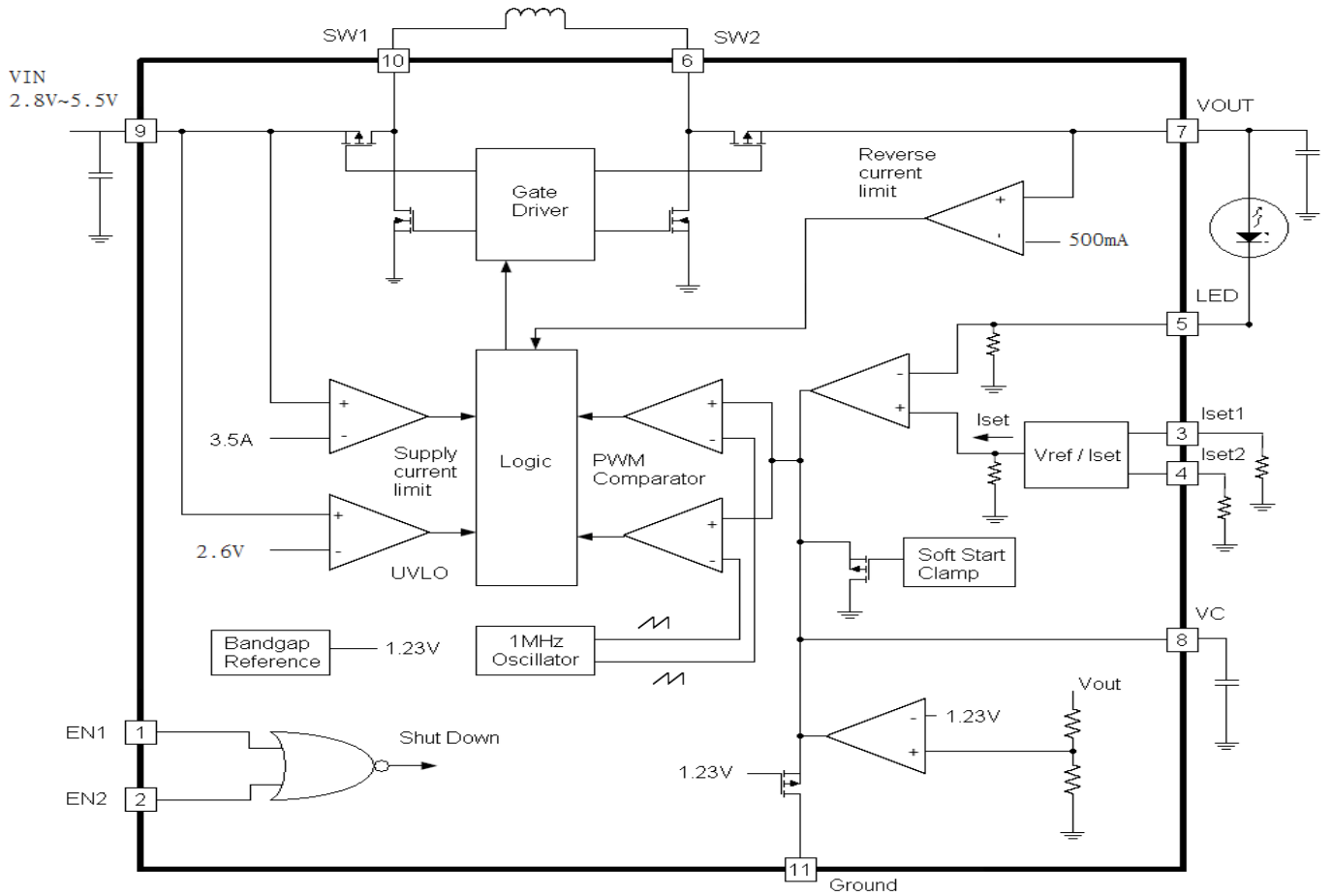

ORDERING INFORMATION

Part Number	Package	Part Marking
SP2354DN10RGB	DFN-10	SP2354

※ SP2354DN10RGB : 7" Tape Reel; Pb – Free, Halogen-Free

ABSOLUTE MAXIMUM RATINGS (TA=25°C, unless otherwise specified.)

The following ratings designate persistent limits beyond which damage to the device may occur.

Symbol	Parameter	Value	Unit
V _{IN}	DC Supply Voltage	-0.3 ~ 6	V
I _{OUT}	Output Current, Source or Sink	1	A
T _J	Operating Junction Temperature Range	125	°C
T _{STG}	Storage Temperature Range	-40 to 125	°C
T _{LEAD}	Lead Soldering Temperature for 5 sec.	260	°C
T _{ope}	Operation Temperature Range	-40 ~ 85	°C
R _{θJC}	Thermal Resistance Junction – Case (*)	10	°C/W



SP2354

1A Buck-Boost LED Driver

ELECTRICAL CHARACTERISTICS

(Unless otherwise stated, these specifications apply $T_A=25^\circ\text{C}$; $V_{IN}=3.6\text{V}$, $R_{ISET}=22\text{K}$)

Symbol	Parameter	Conditions	Min.	Typ.	Max.	Unit
SUPPLY						
V_{IN}	Supply Voltage		2.8		5.5	V
I_{IN}	Supply Current	$2.9\text{V} \leq V_{IN} \leq 5.5\text{V}$		1000	1350	μA
		$2.9\text{V} \leq V_{IN} \leq 5.5\text{V}$, $V_{EN1} = V_{EN2} = 0\text{V}$			1	μA
		$V_{IN} < \text{UVLO}$, $V_{EN1} = V_{EN2} = V_{IN}$		5	10	μA
UVLO	Under Voltage Lockout Threshold	V_{IN} Rising		2.6	2.8	V
		V_{IN} Falling	2.15	2.35		V
OSC	Oscillator Frequency		825	925	1050	KHz
OUTPUT						
V_{OUT}	Maximum V_{OUT}	LED Pin Open, $I_{LED} = 1\text{A}$	5	5.2	5.4	V
V_{ISET}	I_{SET1} and I_{SET2} Voltage	$3.08\text{K} \leq R_{ISET} \leq 20.5\text{K}$	934	954	967	mV
V_{LED}	LED Pin Voltage	$I_{LED} = 1\text{A}$		140		mV
I_{RATIO}^*	LED Output Current to Programmed Current Ratio	$I_{LED} = 500\text{mA}$	3150	3550	3800	
ENABLE						
V_{EN}	Enable Shutdown Voltage		0.2	0.66		V
$V_{EN(NOR)}$	Enable Voltage Normal Operation			0.68	1.2	V
I_{EN}	Enable 1 and Enable 2 Current		-1		1	μA
SOFT START						
T_{SS}	Soft-Start Period	0.9V to 2.1V		300		μS
SWITCHING REGULATOR						
R_{PMOS}^{**}	$R_{DS(on)}$ for Switch A and D	$V_{OUT} = 3.6\text{V}$		170		m Ω
R_{NMOS}^{**}	$R_{DS(on)}$ for Switch B and C			130		m Ω
I_{LPMOS}	Leakage Current for Switch A and D		-1		1	μA
I_{LNMOS}	Leakage Current for Switch B and C		-1		1	μA
I_F	Forward Switch Current Limit	Switch A	2.5	3.5		A
I_R	Reverse Switch Current Limit	Switch D, $V_{OUT} = 3.6\text{V}$		500		mA

* $I_{RATIO} = I_{LED} / (I_{SET1} + I_{SET2})$

** Guaranteed by Design



SP2354

1A Buck-Boost LED Driver

PERFORMANCE CHARACTERISTICS (TA=25°C, unless otherwise specified.)

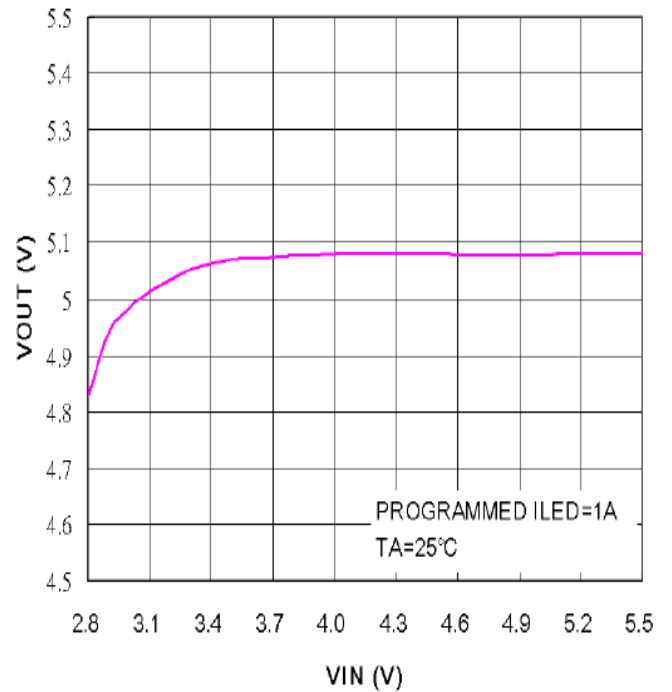
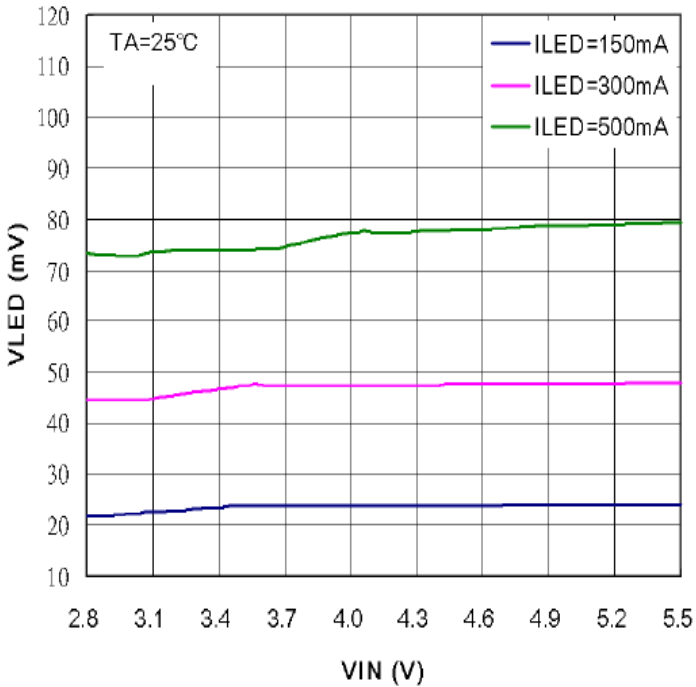
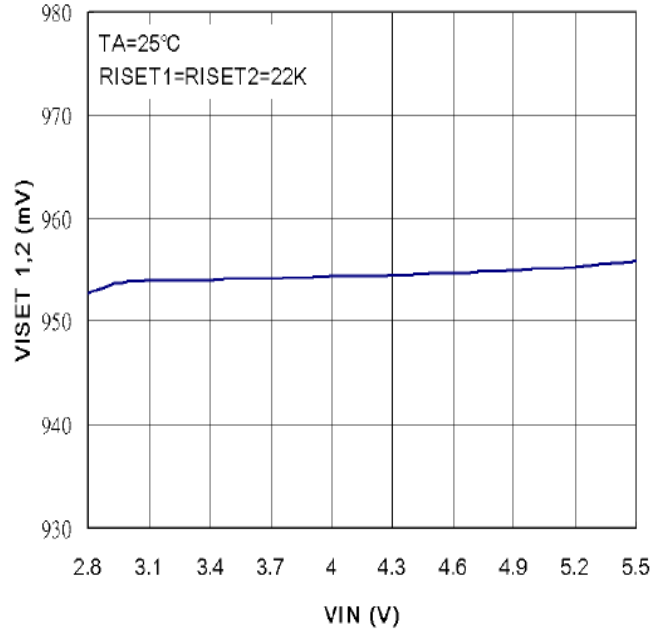
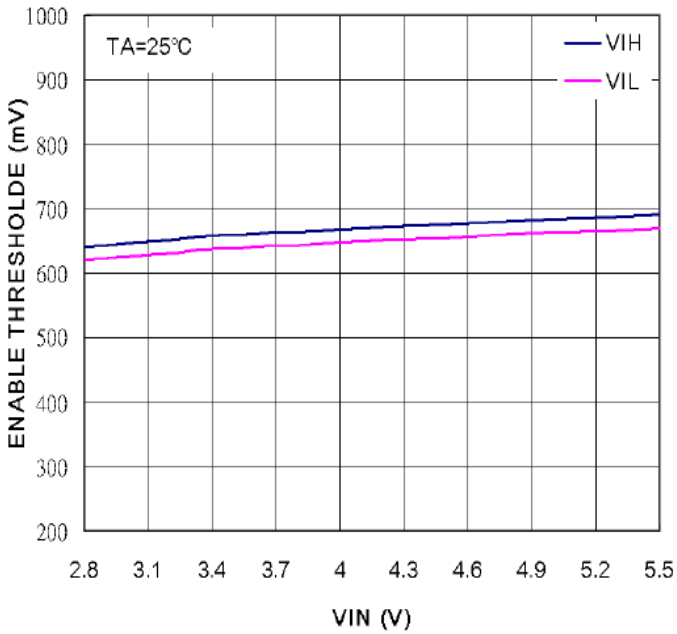



SP2354

1A Buck-Boost LED Driver

PERFORMANCE CHARACTERISTICS (TA=25°C, unless otherwise specified.)

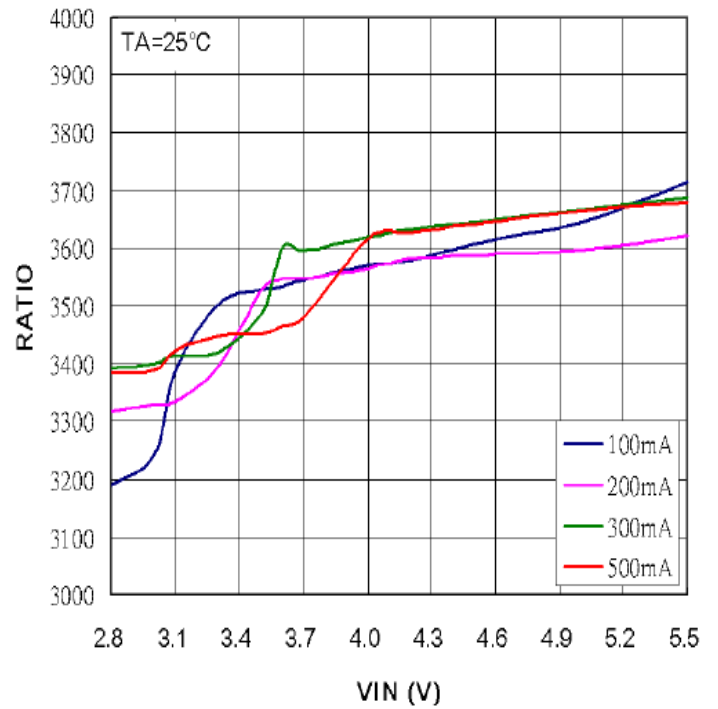
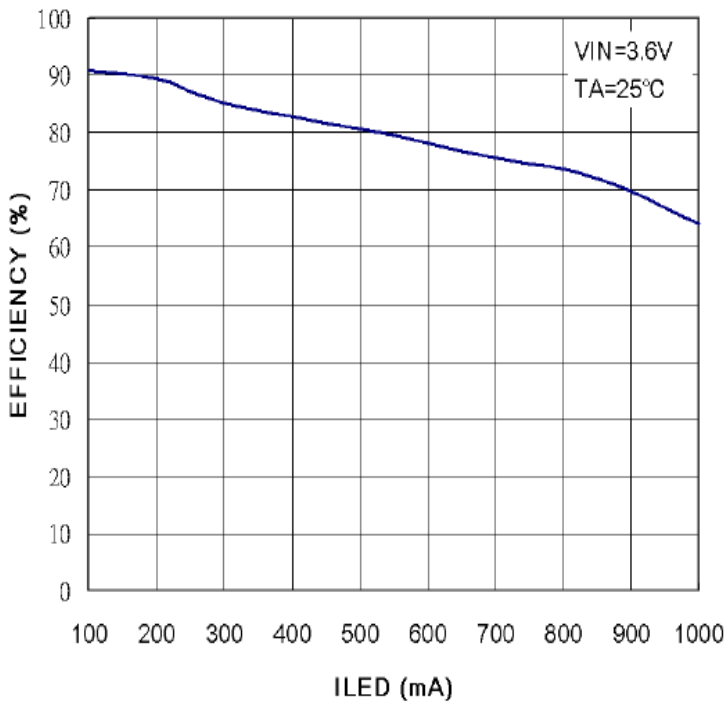
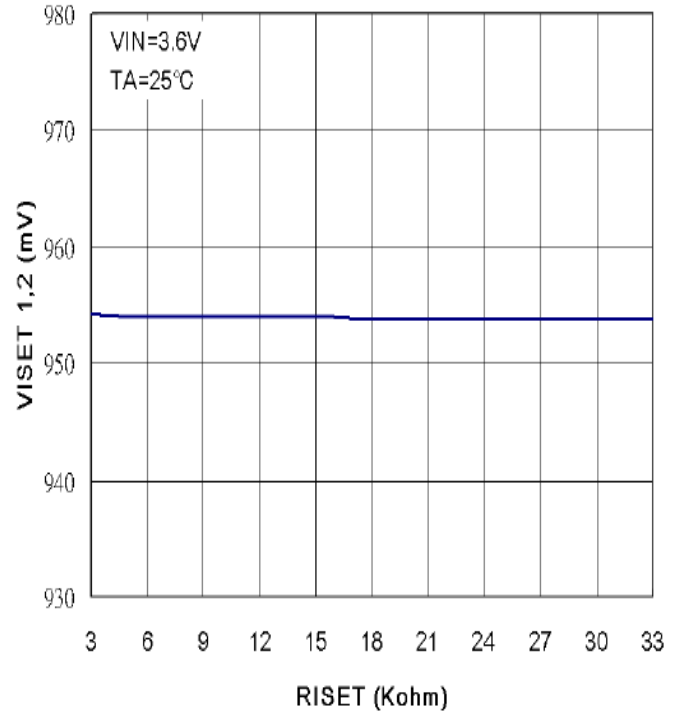
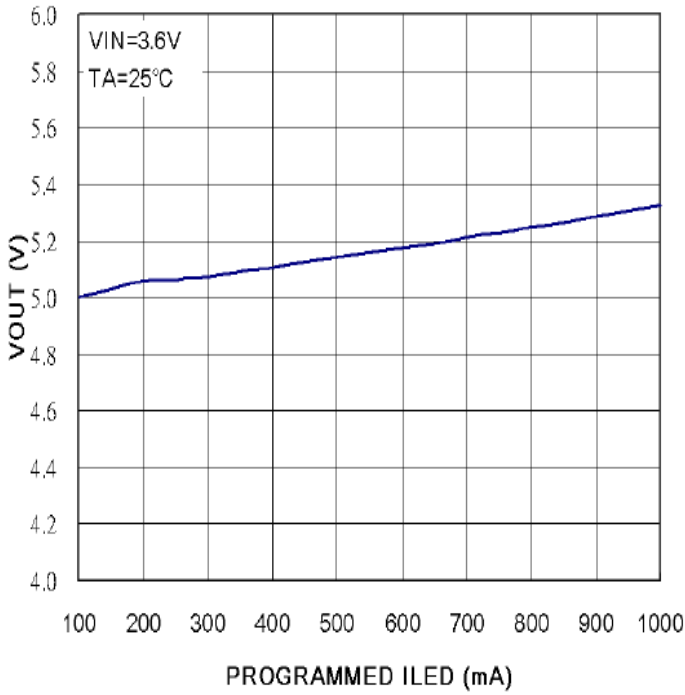



SP2354

1A Buck-Boost LED Driver

DFN-10 PACKAGE OUTLINE

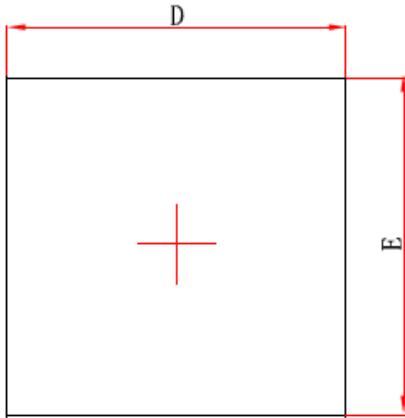

Top View

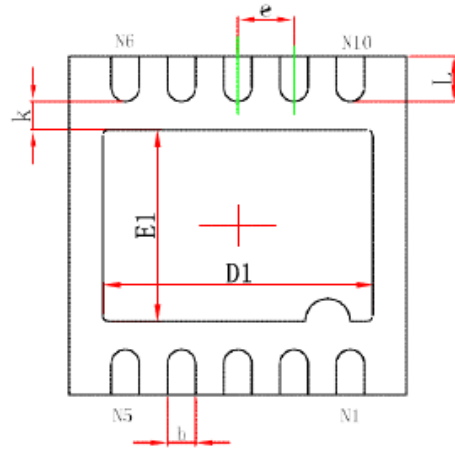

Bottom View

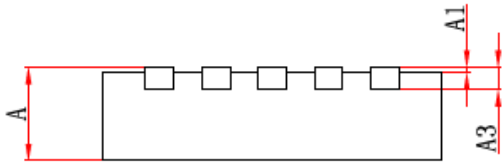

Side View

Symbol	Dimensions In Millimeters		Dimensions In Inches	
	Min.	Max.	Min.	Max.
A	0.700/0.800	0.800/0.900	0.028/0.031	0.031/0.035
A1	0.000	0.050	0.000	0.002
A3	0.203REF.		0.008REF.	
D	2.900	3.100	0.114	0.122
E	2.900	3.100	0.114	0.122
D1	2.300	2.500	0.091	0.098
E1	1.600	1.800	0.063	0.071
k	0.200MIN.		0.008MIN.	
b	0.180	0.300	0.007	0.012
e	0.500TYP.		0.020TYP.	
L	0.300	0.500	0.012	0.020



SP2354

1A Buck-Boost LED Driver

Information provided is alleged to be exact and consistent. SYNC Power Corporation presumes no responsibility for the penalties of use of such information or for any violation of patents or other rights of third parties, which may result from its use. No license is granted by allegation or otherwise under any patent or patent rights of SYNC Power Corporation. Conditions mentioned in this publication are subject to change without notice. This publication surpasses and replaces all information previously supplied. SYNC Power Corporation products are not authorized for use as critical components in life support devices or systems without express written approval of SYNC Power Corporation.

©The SYNC Power logo is a registered trademark of SYNC Power Corporation
©2016 SYNC Power Corporation – Printed in Taiwan – All Rights Reserved
SYNC Power Corporation
7F-2, No.3-1, Park Street
NanKang District (NKSP), Taipei, Taiwan, 115, R.O.C
Phone: 886-2-2655-8178
Fax: 886-2-2655-8468
<http://www.syncpower.com>