



SP6014

Synchronous Rectifier Driver

DESCRIPTION

The fundamental of SP6014 synchronous rectifier (SR) driver IC is based on our U.S. patented methods that utilize the principle of “prediction” logic circuit. The IC deliberates previous cycle timing to linear control the SR in present cycle by “predictive” algorithm that makes adjustments to the turn-off time, in order to achieve maximum efficiency and avoid cross-conduction at the same time. Specially, SP6014 is designed for LLC applications, and variable switching frequency system .

APPLICATIONS

- Switching Mode Power Supply (CCM&DCM&QR) for Flyback , Forward or LLC Applications
- Storage area network power supplies
- Telecommunication converters
- Embedded systems
- Industrial & commercial systems using high current processors
- Power converters to meet Lot 6 requirement

FEATURES

- Offers efficiency improvement over Schottky Diode.
- Low Standby Power to meet DOE Lot 6 Requirement .
- Drives all level Power MOSFET.
- Prediction gate timing control.
- Minimum MOSFET body diode conduction.
- Operating frequency up to 250 KHz.
- Synchronize to transformer secondary voltage waveform.
- Self detect DCM / CCM to enhance the performance under the variable switching frequency condition.

PIN CONFIGURATION (SOP-8)

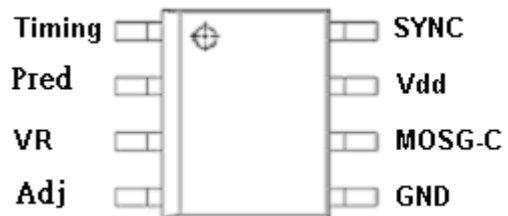

PART MARKING





SP6014 Synchronous Rectifier Driver

TYPICAL APPLICATION CIRCUIT

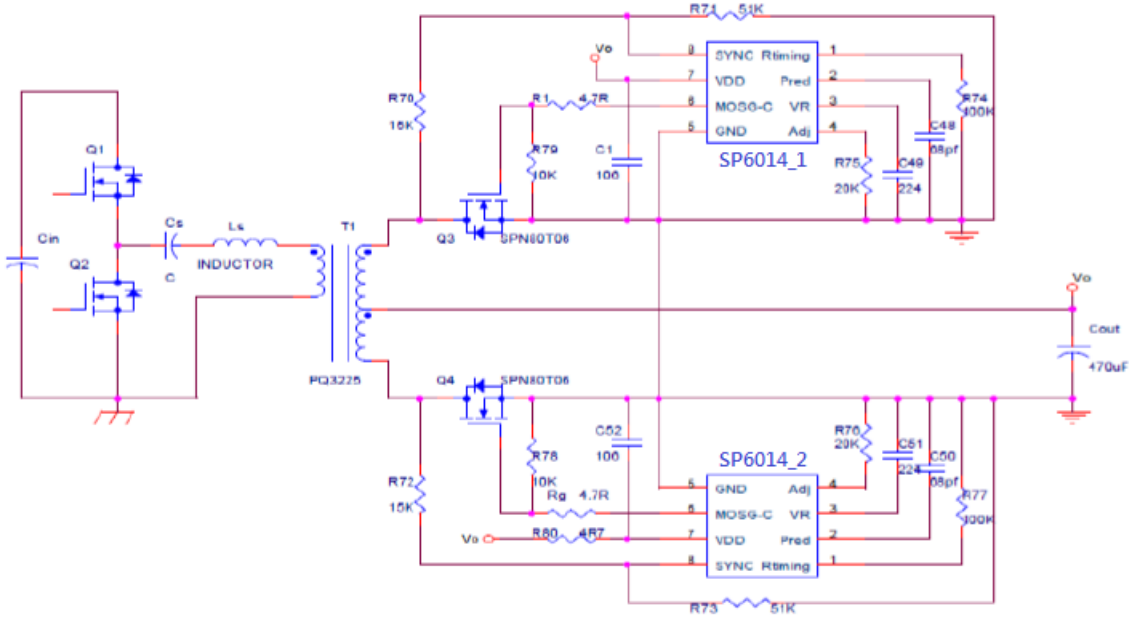

PIN DESCRIPTION

Pin	Symbol	Description
1	Timing	Discontinuous current filter timing adjustment resistor connection.
2	Pred	Capacitor to store previous cycle timing for SR MOSFET.
3	VR	Voltage Regulator.
4	Adj	Trigger point adjustment for Dynamic state.
5	GND	Ground connection.
6	MOSG-C	Catch MOSFET gate drive.
7	Vdd	DC supply voltage.
8	SYNC	Synchronized signal from the V_{DS} of SR MOSFET.



SP6014

Synchronous Rectifier Driver

BLOCK DIAGRAM

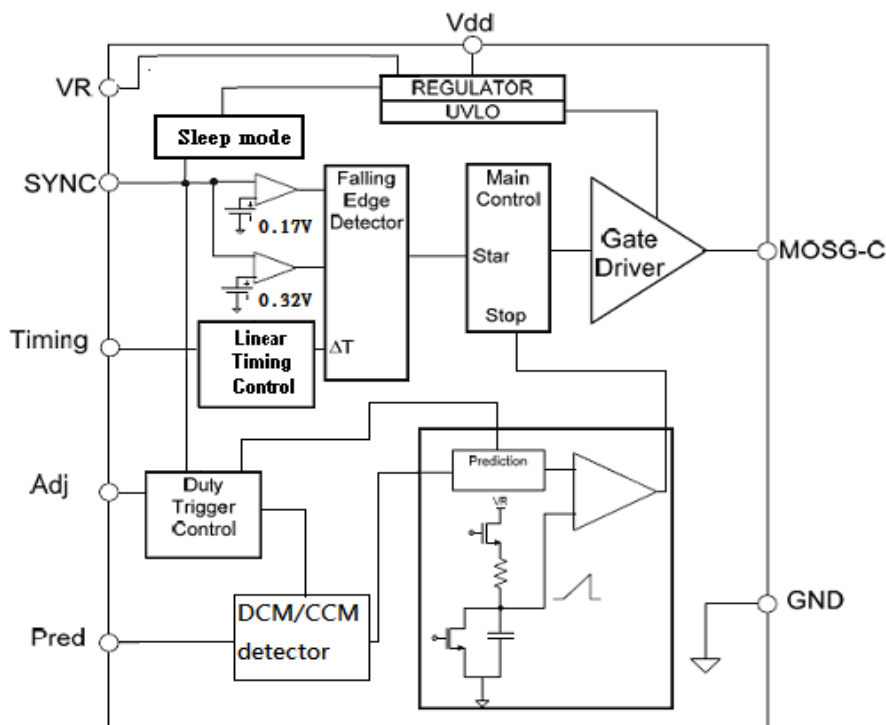

ORDERING INFORMATION

Part Number	Package	Part Marking
SP6014S8RGB	SOP-8	SP6014

※ SP6014S8RGB : Tape Reel ; Pb – Free ; Halogen - Free

ABSOLUTE MAXIMUM RATINGS (TA=25°C, unless otherwise specified.)

The following ratings designate persistent limits beyond which damage to the device may occur.

Symbol	Parameter	Value	Unit
V _{dd}	DC Supply Voltage	16	V
I _{OUT}	Peak Source Current (Pulsed)	2.0	A
	Peak Sink Current (Pulsed)	2.0	A
P _D	Power Dissipation @ T _A =85°C (*)	0.25	W
T _J	Operating Junction Temperature Range	-40 to 125	°C
T _{STG}	Storage Temperature Range	-40 to 150	°C
T _{LEAD}	Lead Soldering Temperature for 5 sec.	260	°C

THERMAL RESISTANCE

Symbol	Parameter	Value	Unit
R _{ΘJA}	Thermal Resistance Junction to Ambient (*)	150	°C/W

(*) The power dissipation and thermal resistance are evaluated under copper board mounted with free air conditions.



SP6014

Synchronous Rectifier Driver

ELECTRICAL CHARACTERISTICS

($T_A=25^{\circ}\text{C}$, $V_{dd}=12\text{V}$, Freq. =50 KHz, Duty Cycle=50%, unless otherwise specified.)

Symbol	Parameter	Conditions	Min.	Typ.	Max.	Unit
SUPPLY INPUT						
IDD	Supply current	Sleep mode		0.25		mA
		$V_{SYNC}=V_{dd}$, Normal mode	1.8	2.3	3.0	mA
Vdd	Supply voltage	Idd peak < 2A			16	V
Vdd on	Enable voltage		8.0	8.5	9.0	V
Vdd hysteresis	Enable voltage		0.05	0.30	0.6	V
Vovp	Over voltage protection		16	16.5	17	V
Vovp hysteresis			0.1	0.35	0.6	V
SYNC REFERENCE (SYNC)						
Vshth	SYNC high threshold			3.2		V
Vslth	SYNC low threshold			0.16		V
Vsync	SYNC wake-up voltage	I _{sync} =3mA		10		V
I _{sync}	SYNC input current				3	mA
Voltage Regulator REFERENCE (VR)						
VR	voltage		5.2		5.4	V
I _{VR}	VR Output Current				50	mA
ON TIME DUTY SETUP (PIN 6)						
T _{on-time}		Frequency= 10KHz-20KHz, Duty=20%~50%		26	32	uS
MOSFET GATE DRIVER (MOSG-C)						
V _{oh}	Output high voltage	I _o =-200mA	10.4	11.0		V
V _{ol}	Output low voltage	I _o =200mA		0.5	0.8	V
T _d	Propagation delay	No load	220	275	350	nS
T _{pred}		Pin2 open		120		nS
T _r	Rise time	Load = 1nF (*)		10	25	nS
T _f	Fall time	Load = 1nF (*)		10	25	nS
Dynamic Protect						
D _t	Dynamic variable	Pin 4 , 25KΩ		500		nS
T _{on-min}	MOSG-C on time	PWM adjusts time > D _t	0.45	0.6	0.85	uS

(*) Tr & Tf are measured among 10% and 90% of starting and final voltage.

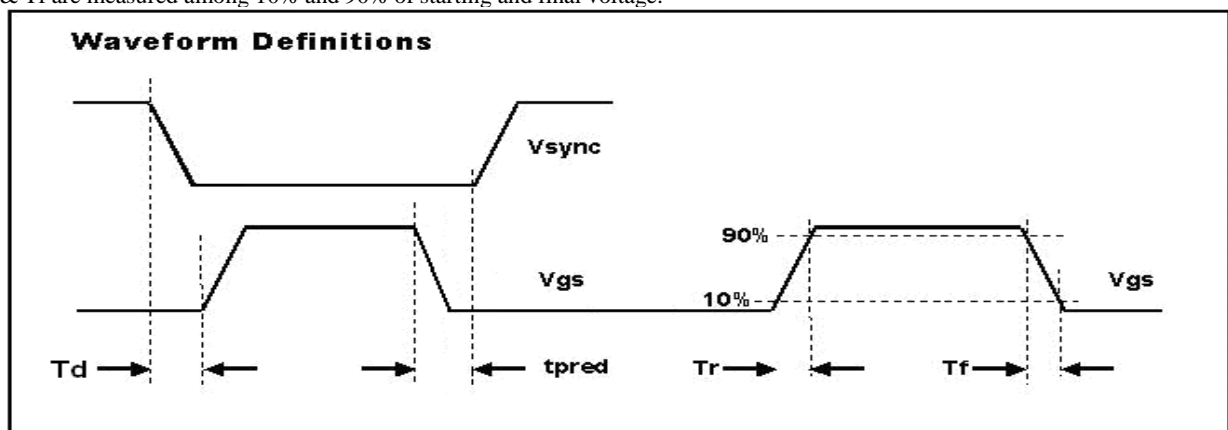



SP6014

Synchronous Rectifier Driver

PERFORMANCE CHARACTERISTICS ($T_A=25^{\circ}\text{C}$, unless otherwise specified.)

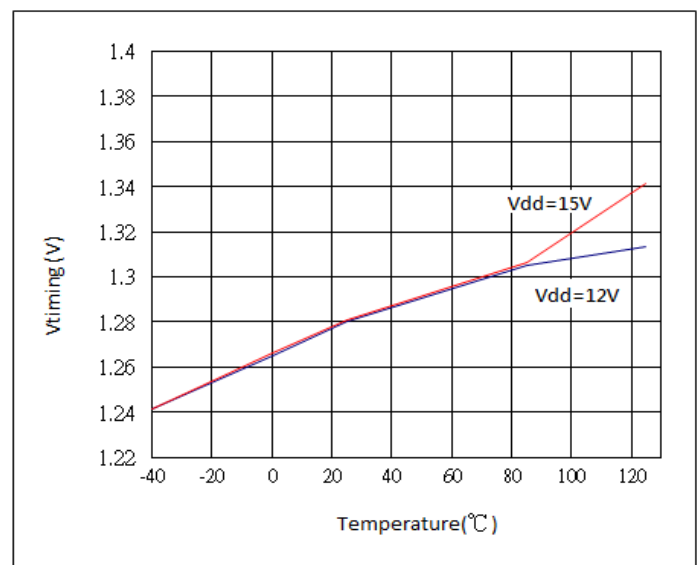
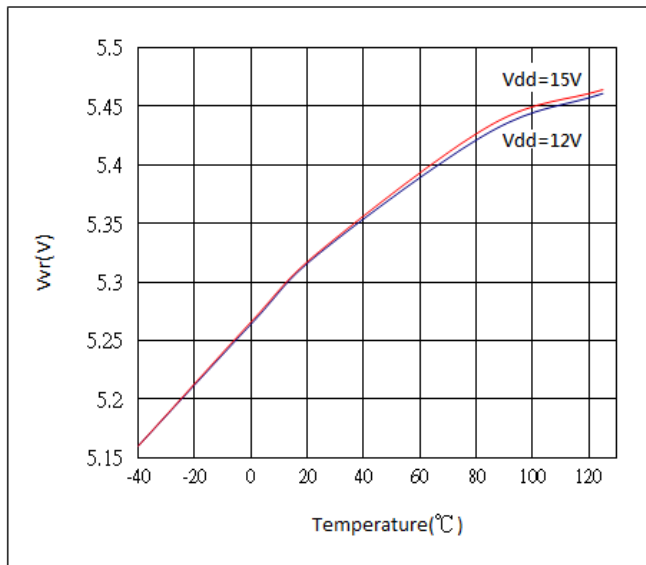
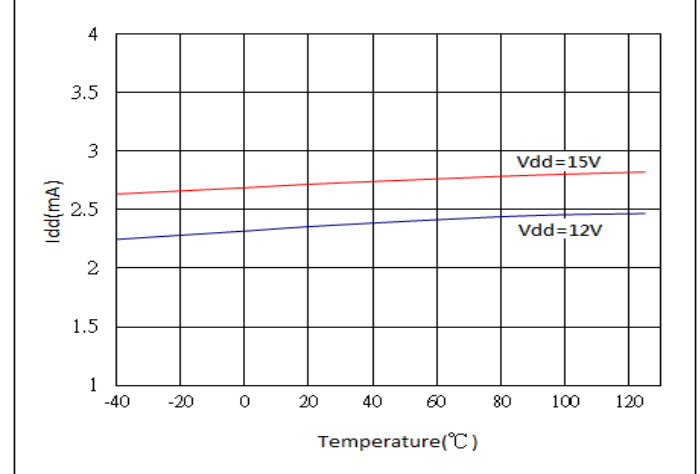
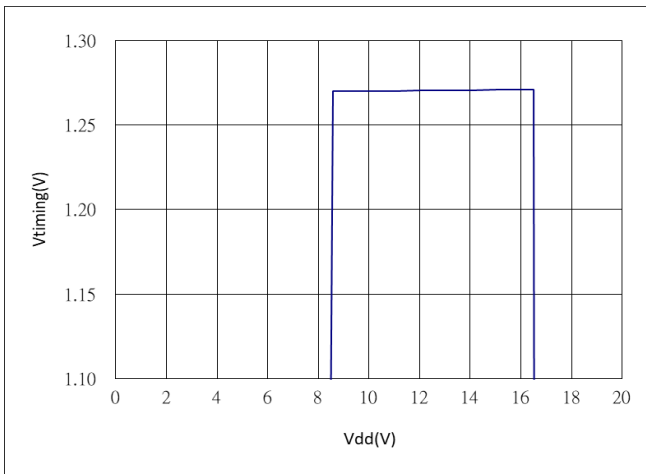
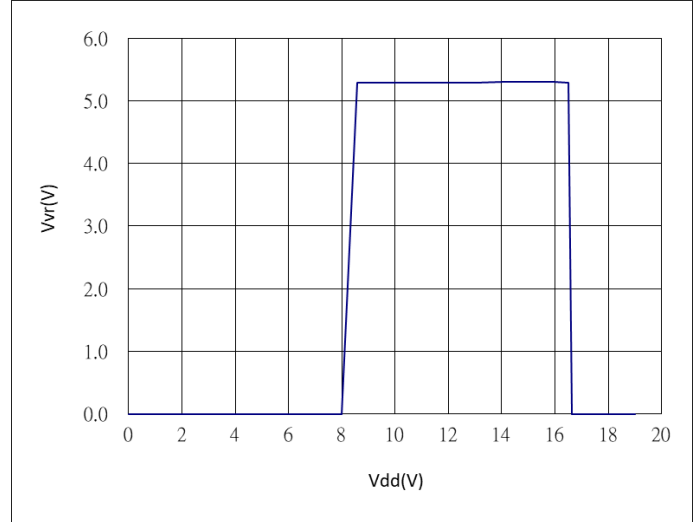
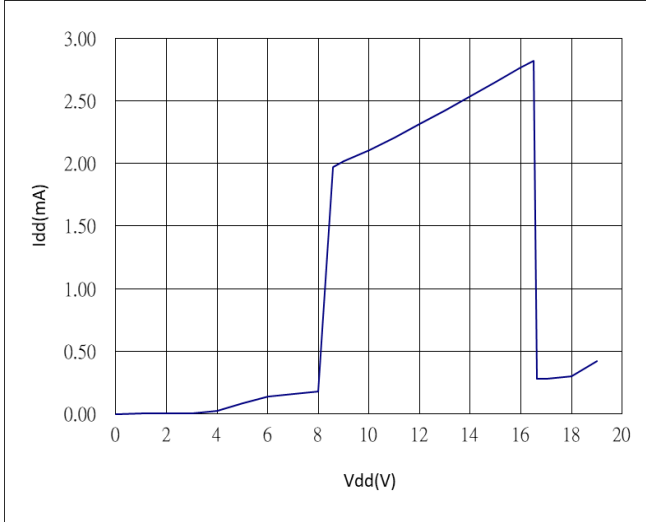



SP6014

Synchronous Rectifier Driver

PERFORMANCE CHARACTERISTICS ($T_A=25^{\circ}\text{C}$, unless otherwise specified.)

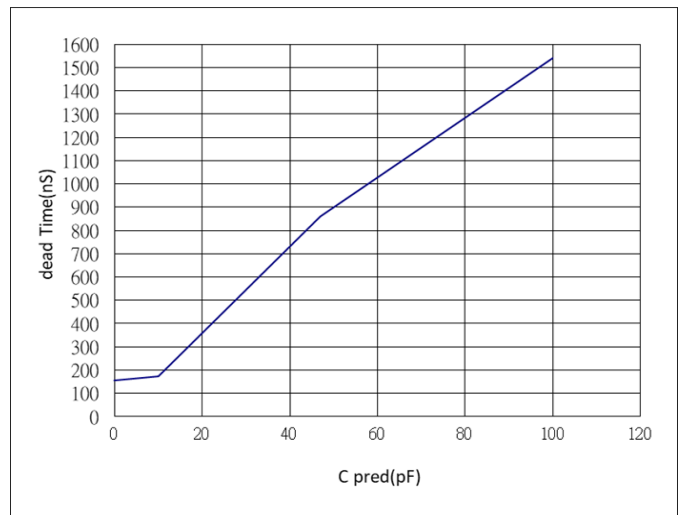
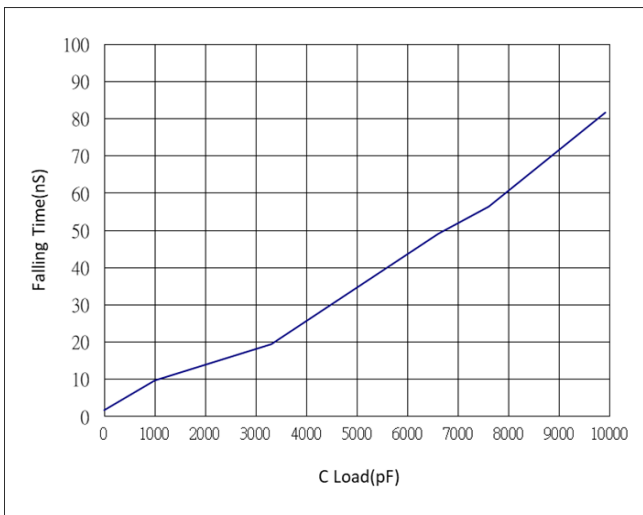
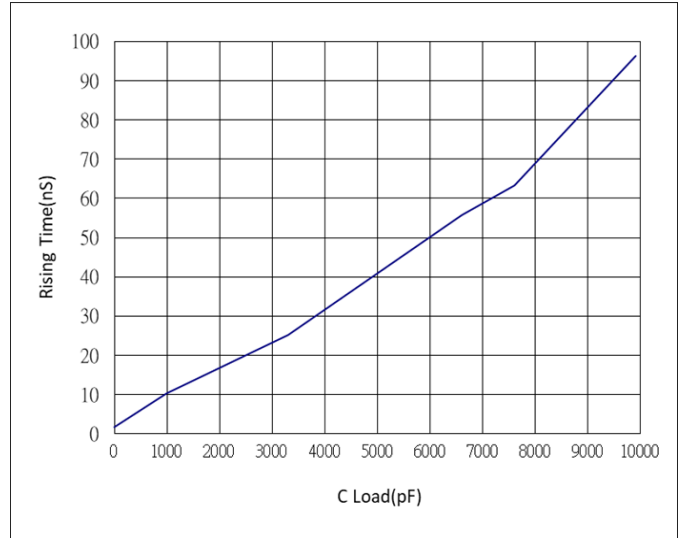
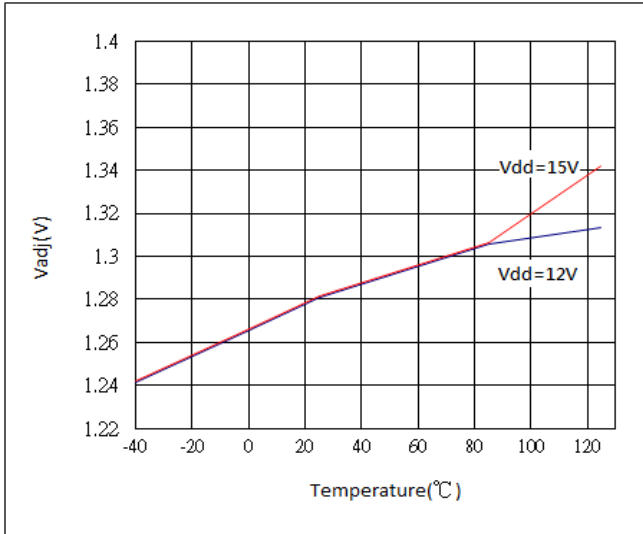



SP6014

Synchronous Rectifier Driver

SOP-8 PACKAGE OUTLINE

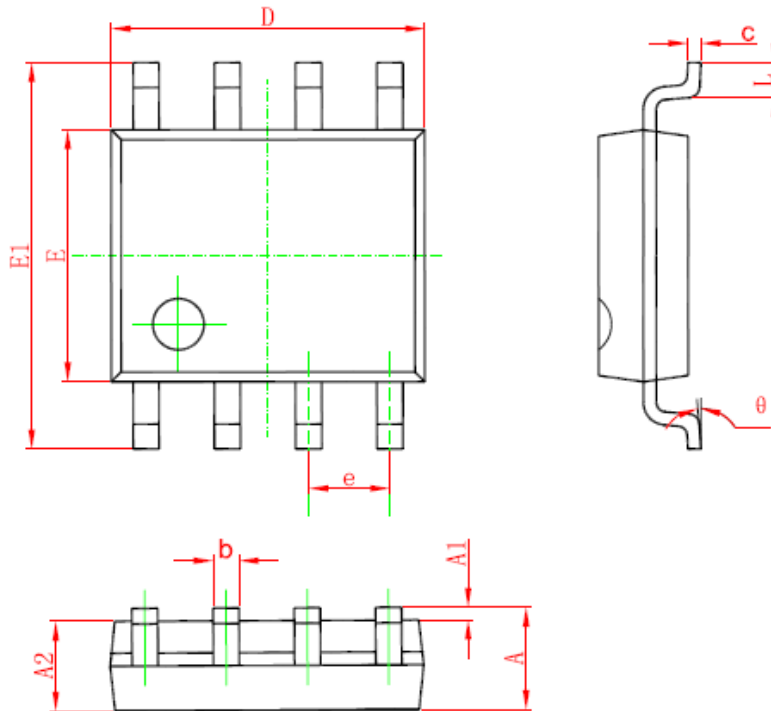

Symbol	Dimensions In Millimeters		Dimensions In Inches	
	Min	Max	Min	Max
A	1.350	1.750	0.053	0.069
A1	0.100	0.250	0.004	0.010
A2	1.350	1.550	0.053	0.061
b	0.330	0.510	0.013	0.020
c	0.170	0.250	0.006	0.010
D	4.700	5.100	0.185	0.200
E	3.800	4.000	0.150	0.157
E1	5.800	6.200	0.228	0.244
e	1.270 (BSC)		0.050 (BSC)	
L	0.400	1.270	0.016	0.050
θ	0°	8°	0°	8°



SP6014

Synchronous Rectifier Driver

Information provided is alleged to be exact and consistent. SYNC Power Corporation presumes no responsibility for the penalties of use of such information or for any violation of patents or other rights of third parties, which may result from its use. No license is granted by allegation or otherwise under any patent or patent rights of SYNC Power Corporation. Conditions mentioned in this publication are subject to change without notice. This publication surpasses and replaces all information previously supplied. SYNC Power Corporation products are not authorized for use as critical components in life support devices or systems without express written approval of SYNC Power Corporation.

© The SYNC Power logo is a registered trademark of SYNC Power Corporation

© 2018 SYNC Power Corporation – Printed in Taiwan – All Rights Reserved

SYNC Power Corporation

7F-2, No.3-1, Park Street

NanKang District (NKSP), Taipei, Taiwan, 115, R.O.C

Phone: 886-2-2655-8178

Fax: 886-2-2655-8468

<http://www.syncpower.com>