



SP6016E

Synchronous Rectifier Driver

DESCRIPTION

The fundamental of SP6016E synchronous rectifier (SR) driver IC is based on our U.S. patented methods that utilize the principle of “prediction” logic circuit. The IC deliberates previous cycle timing to control the SR in present cycle by “predictive” algorithm that makes adjustments to the turn-off time, in order to achieve maximum efficiency and avoid cross-conduction at the same time. Specially, SP6016E is designed for Resonance. It also maintains the MOSFET’s body diode conduction at minimum level. The SP6016E is capable to adapt in almost all existing Resonance converters with few adjustments considered necessary.

FEATURES

- Offers efficiency improvement over Schottky Diode (depends on drive configuration of the SR).
- Low Standby Power to meet DOE Lot 6 requirement.
- Drives all logic level Power MOSFET.
- Prediction gate timing control.
- Minimum MOSFET body diode conduction.
- Operating frequency up to 300 KHz.
- Synchronize to transformer secondary voltage waveform.
- Internal over voltage protection

APPLICATIONS

- Switching Mode Power Supply (CCM&DCM&QR)
- Storage area network power supplies
- Telecommunication converters
- Embedded systems
- Industrial & commercial systems using high current processors
- Power converters to meet Lot 6 requirement

PIN CONFIGURATION (SOT-23-6L)

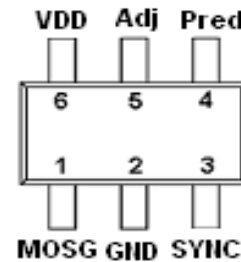

PART MARKING

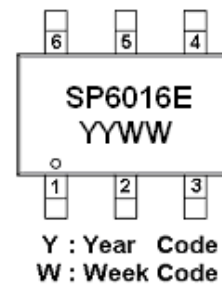



SP6016E

Synchronous Rectifier Driver

TYPICAL APPLICATION CIRCUIT

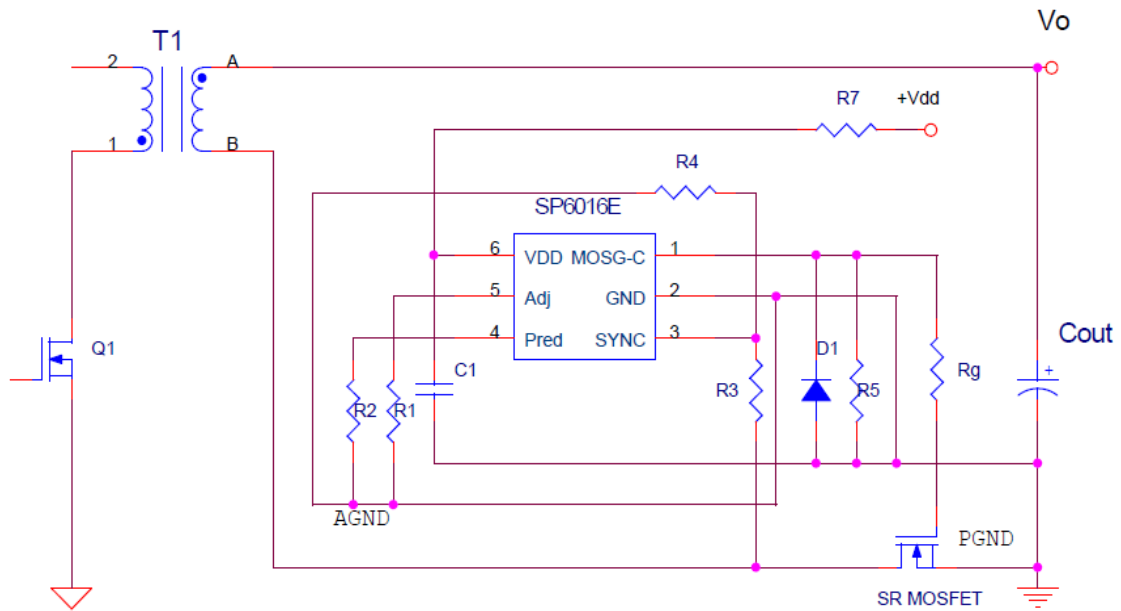

PIN DESCRIPTION

Pin	Symbol	Description
1	MOSG-C	Catch MOSFET gate drive.
2	GND	Ground connection.
3	SYNC	Synchronized signal from the VDS of SR MOSFET.
4	Pred	By connecting a resistor to ground to set the dead time.
5	Adj	Trigger point adjustment for Dynamic state.
6	Vdd	DC supply voltage.



SP6016E

Synchronous Rectifier Driver

BLOCK DIAGRAM

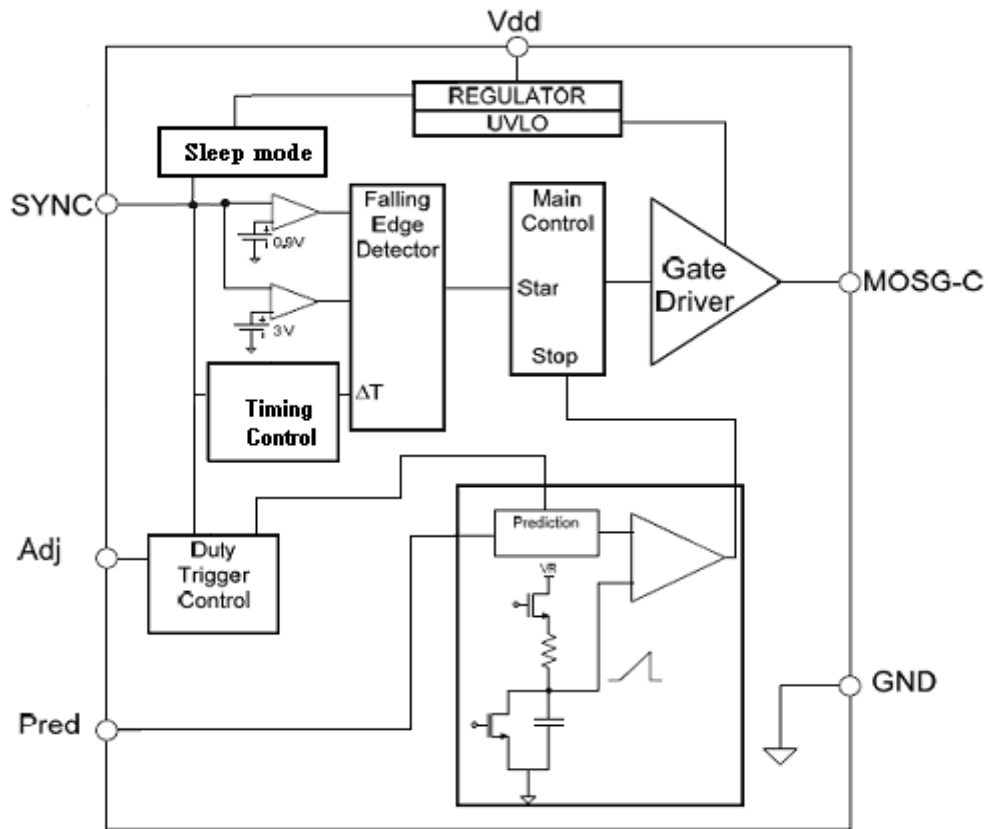

ORDERING INFORMATION

Part Number	Package	Part Marking
SP6016ES26RGB	SOT-23-6L	SP6016E

※ SP6016ES26RGB : 7" Tape Reel ; Pb – Free ; Halogen - Free

ABSOLUTE MAXIMUM RATINGS (TA=25°C, unless otherwise specified.)

The following ratings designate persistent limits beyond which damage to the device may occur.

Symbol	Parameter	Value	Unit
V _{dd}	DC Supply Voltage	16	V
I _{OUT}	Peak Source Current (Pulsed)	1.0	A
	Peak Sink Current (Pulsed)	1.5	A
P _D	Power Dissipation @ T _A =85°C (*)	0.3	W
T _J	Operating Junction Temperature Range	-40 to 125	°C
T _{STG}	Storage Temperature Range	-40 to 150	°C
T _{LEAD}	Lead Soldering Temperature for 5 sec.	260	°C

THERMAL RESISTANCE

Symbol	Parameter	Value	Unit
R _{θJC}	Thermal Resistance Junction – Case (*)	110	°C/W

(*) The power dissipation and thermal resistance are evaluated under copper board mounted with free air conditions.



SP6016E

Synchronous Rectifier Driver

ELECTRICAL CHARACTERISTICS

($T_A=25^{\circ}\text{C}$, $V_{dd}=12\text{V}$, Freq. =50 KHz, Duty Cycle=50%, unless otherwise specified.)

Symbol	Parameter	Conditions	Min.	Typ.	Max.	Unit
SUPPLY INPUT						
I _{dd}	Supply current	No load & Sleep mode		0.2	0.35	mA
		V _{SYNC} =V _{dd} , No load	2.0	3.5	4.5	mA
V _{dd}	Supply voltage	I _{dd peak} < 1A	4.5		16	V
V _{dd on}	Enable voltage		3.4	3.7	4.1	V
V _{dd hysteresis}	Enable voltage		0.1	0.3	0.5	V
V _{ovp}	Over voltage protection		17	17.8	18.5	V
V _{ovp hysteresis}			0.5	0.7	1.0	V
SYNC REFERENCE (SYNC)						
V _{shth}	SYNC high threshold			3.0		V
V _{slth}	SYNC low threshold			0.9		V
V _{sync}	SYNC clamp voltage	I _{sync} =3mA	V _{dd} +1.5			V
V _{sync WK}	SYNC wake-up voltage	Pulse width >1uS for V _{dd} =5V	7			V
V _{sync WK}	SYNC wake-up voltage	Pulse width >1uS for V _{dd} =12V	8.5			V
I _{sync}	SYNC input current				3	mA
REFERENCE Voltage (V_{Pred})						
V _{Pred}		Pin 4=15K Ω		1.25		V
ON TIME DUTY SETUP (PIN 1)						
T _{on-time}				23		us
MOSFET GATE DRIVER (MOSG-C)						
V _{oh}	Output high voltage	I _o = -200mA		10.7		V
V _{ol}	Output low voltage	I _o = 200mA		0.3		V
T _d	Propagation delay	No load, Pin4=5.1K Ω		100		ns
T _{pred}	Dead time	No load, Pin4=5.1K Ω		165		ns
T _r	Rise time	Load = 1nF (*)		11		ns
T _f	Fall time	Load = 1nF (*)		8		ns
Dynamic Protect						
D _t	Dynamic variable	Pin 5=15K Ω		450		ns
T _{on-min}	MOSG-C on time	PWM adjusts time > D _t		1.3		us

(*) T_r & T_f are measured among 10% and 90% of starting and final voltage.

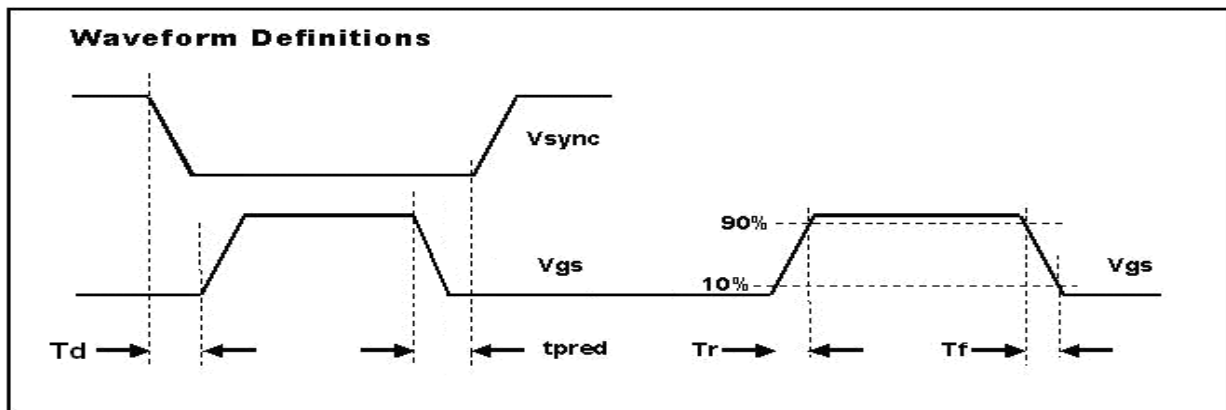



SP6016E

Synchronous Rectifier Driver

PERFORMANCE CHARACTERISTICS (TA=25°C, unless otherwise specified.)

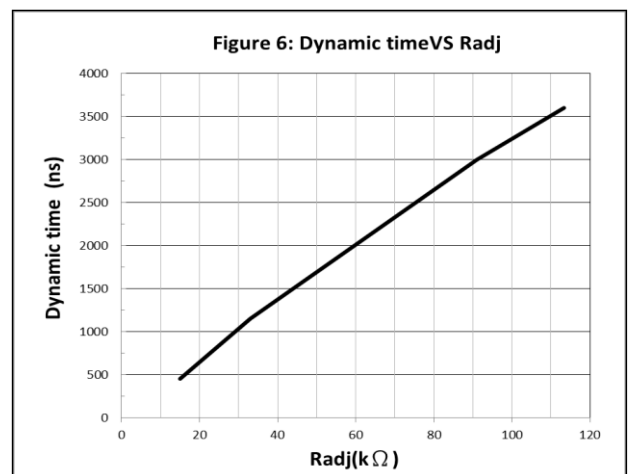
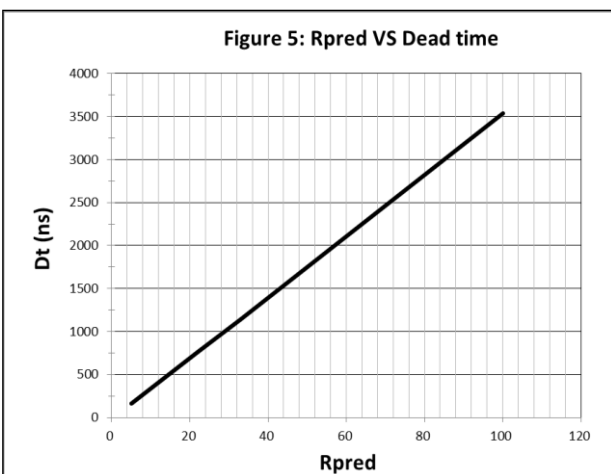
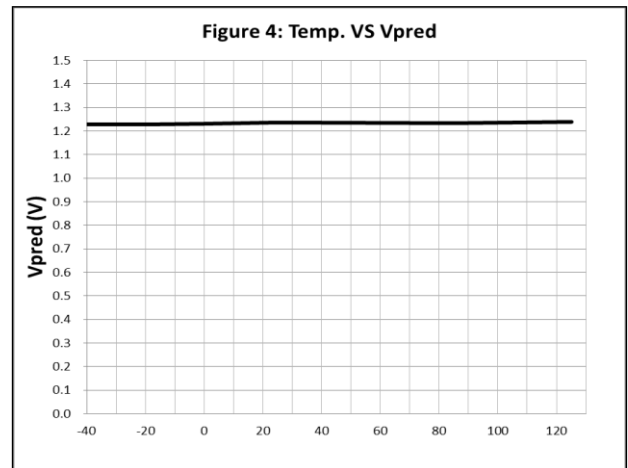
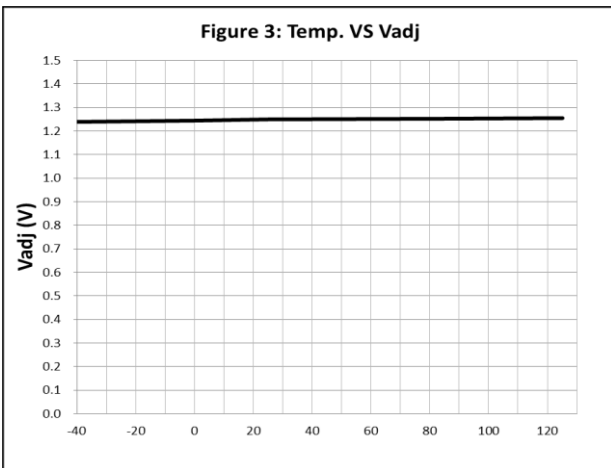
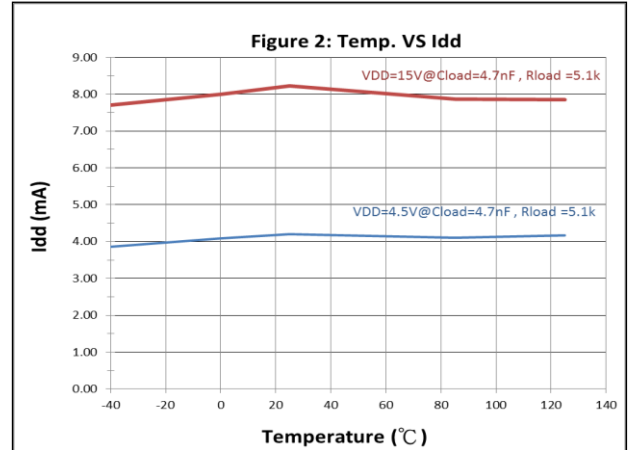
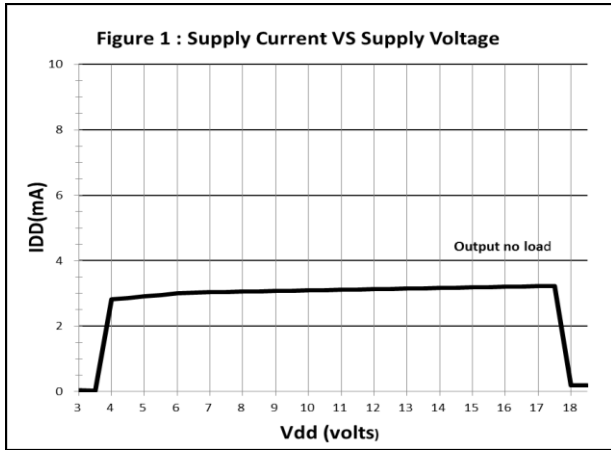



SP6016E

Synchronous Rectifier Driver

PERFORMANCE CHARACTERISTICS ($T_A=25^{\circ}\text{C}$, unless otherwise specified.)

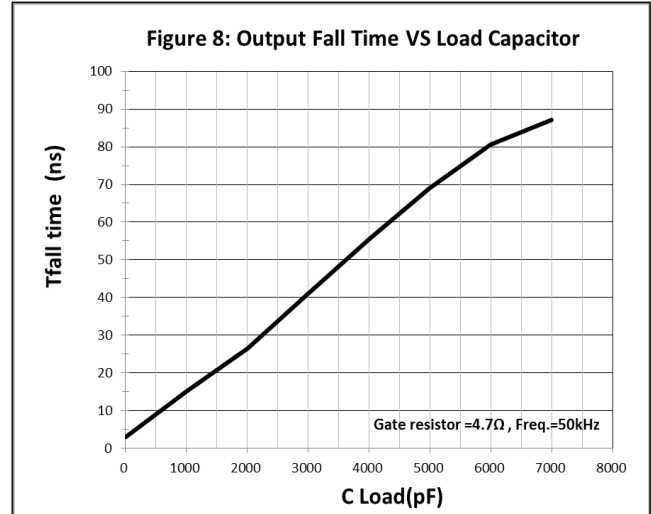
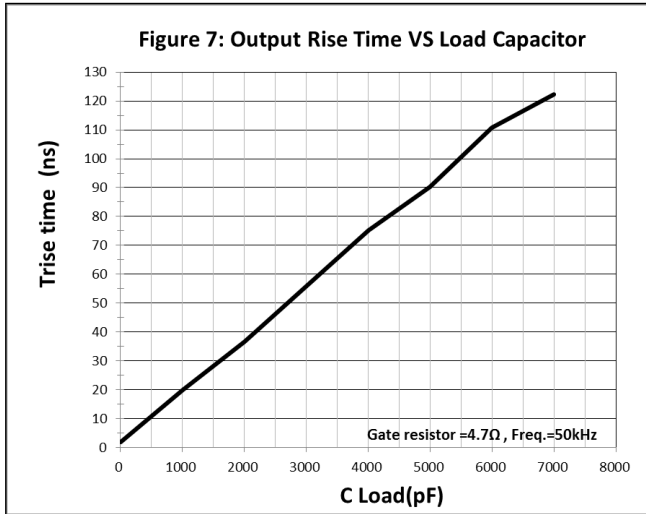



SP6016E

Synchronous Rectifier Driver

SOT-23-6L PACKAGE OUTLINE

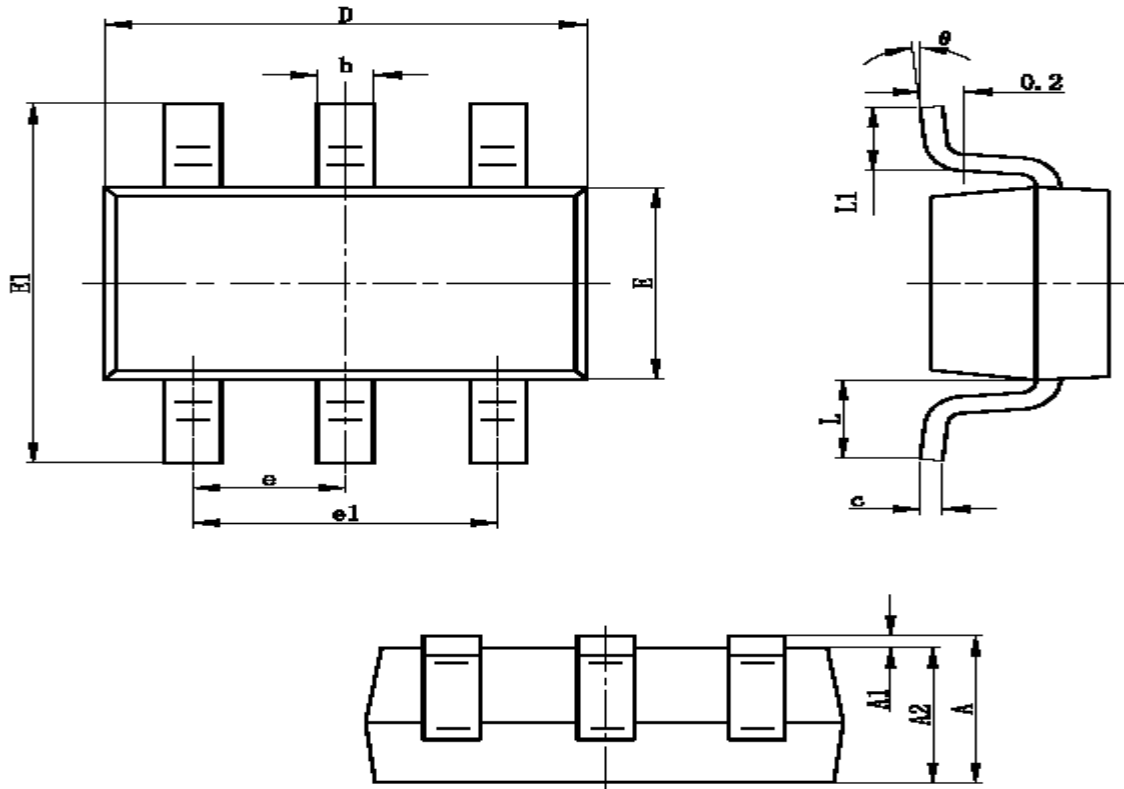

Symbol	Dimensions In Millimeters		Dimensions In Inches	
	Min	Max	Min	Max
A	1.050	1.250	0.041	0.049
A1	0.000	0.100	0.000	0.004
A2	1.050	1.150	0.041	0.045
b	0.300	0.400	0.012	0.016
c	0.100	0.200	0.004	0.008
D	2.820	3.020	0.111	0.119
E	1.500	1.700	0.059	0.067
E1	2.650	2.950	0.104	0.116
e	0.950TYP		0.037TYP	
e1	1.800	2.000	0.071	0.079
L	0.700REF		0.028REF	
L1	0.300	0.600	0.012	0.024
θ	0°	8°	0°	8°



SP6016E

Synchronous Rectifier Driver

Information provided is alleged to be exact and consistent. SYNC Power Corporation presumes no responsibility for the penalties of use of such information or for any violation of patents or other rights of third parties, which may result from its use. No license is granted by allegation or otherwise under any patent or patent rights of SYNC Power Corporation. Conditions mentioned in this publication are subject to change without notice. This publication surpasses and replaces all information previously supplied. SYNC Power Corporation products are not authorized for use as critical components in life support devices or systems without express written approval of SYNC Power Corporation.

© The SYNC Power logo is a registered trademark of SYNC Power Corporation

© 2016 SYNC Power Corporation – Printed in Taiwan – All Rights Reserved

SYNC Power Corporation

7F-2, No.3-1, Park Street

NanKang District (NKSP), Taipei, Taiwan, 115, R.O.C

Phone: 886-2-2655-8178

Fax: 886-2-2655-8468

<http://www.syncpower.com>