



SP6052

High Frequency Synchronous Rectifier Driver

DESCRIPTION

The fundamental of SP6052 synchronous rectifier (SR) driver IC is based on our U.S. patented methods that utilize the principle of “prediction” logic circuit. The IC deliberates previous cycle timing to control the SR in present cycle by “predictive” algorithm that makes adjustments to the turn-off time, in order to achieve maximum efficiency and avoid cross-conduction at the same time. SP6052 is especially suitable for Forward and DC/DC Module.

APPLICATIONS

- Storage area network power supplies
- Servers & workstations
- Embedded systems
- Industrial & commercial systems using high current processors
- Telecommunication converters
- DC/DC Power Module

FEATURES

- Offers efficiency improvement over Schottky Diode (depends on drive configuration of the SR).
- Drives all Power MOSFET
- Prediction gate timing control.
- Minimum MOSFET body diode conduction.
- Operating at high switching frequency 500Khz.
- Synchronize to transformer secondary voltage waveform.
- Linear setting of timing function.
- Minimum VDS pulse masking function
- Bi-directional rapid load protection function.
- Self-detecting DCM / CCM to enhance the performance under the variable switching frequency condition.
- SOP-8 Package

PIN CONFIGURATION (SOP-8)

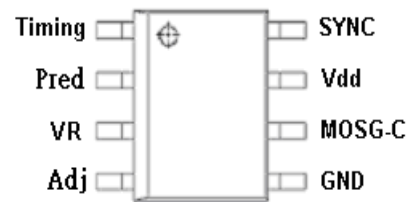

PART MARKING





SP6052

High Frequency Synchronous Rectifier Driver

BLOCK DIAGRAM

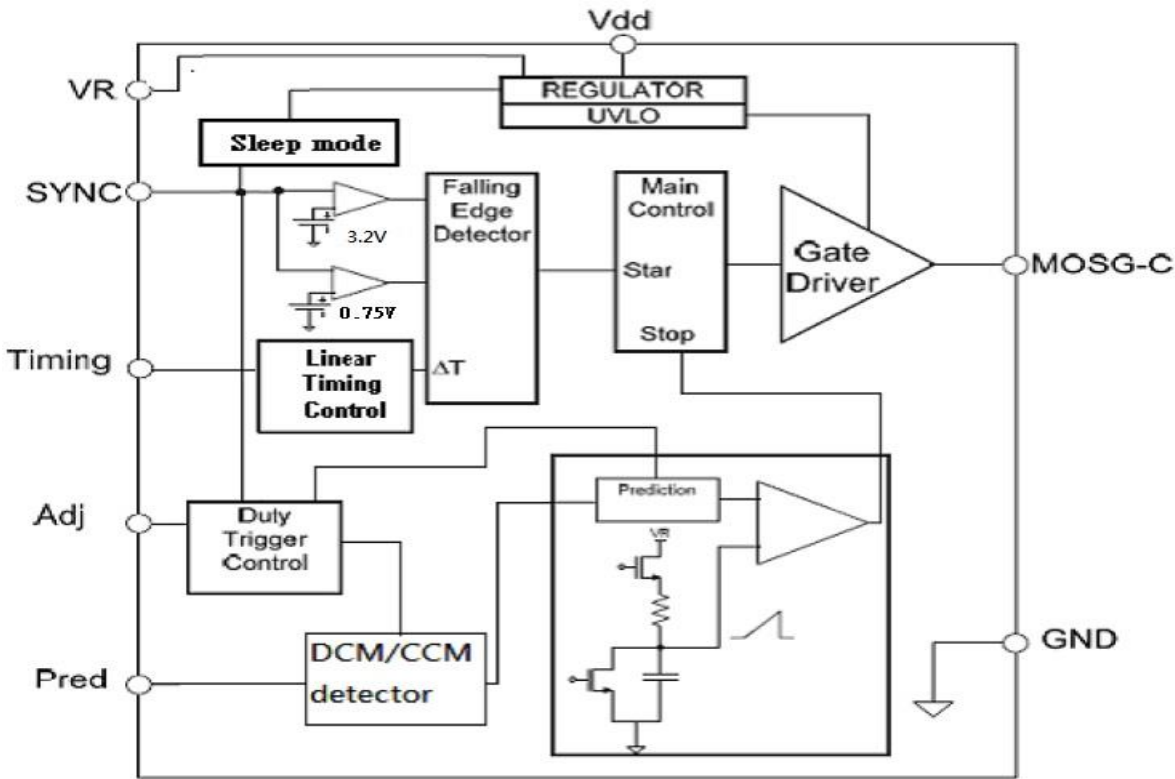

ORDERING INFORMATION

Part Number	Package	Part Marking
SP6052S8RGB	SOP-8	SP6052

※ SP6052S8RGB : Tape Reel ; Pb – Free ; Halogen - Free

ABSOLUTE MAXIMUM RATINGS (TA=25°C, unless otherwise specified.)

The following ratings designate persistent limits beyond which damage to the device may occur.

Symbol	Parameter	Value	Unit
Vdd	DC Supply Voltage	16	V
IOUT	Peak Source Current (Pulsed)	2.0	A
	Peak Sink Current (Pulsed)	2.0	A
PD	Power Dissipation @ TA=85°C(*)	0.25	W
TJ	Operating Junction Temperature Range	-40 to 150	°C
TSTG	Storage Temperature Range	-40 to 150	°C
TLEAD	Lead Soldering Temperature for 5 sec.	260	°C

THERMAL RESISTANCE

Symbol	Parameter	Value	Unit
RθJA	Thermal Resistance Junction to Ambient (*)	150	°C/W

(*) The power dissipation and thermal resistance are evaluated under copper board mounted with free air conditions.



SP6052

High Frequency Synchronous Rectifier Driver

ELECTRICAL CHARACTERISTICS

($T_A=25^{\circ}\text{C}$, $V_{DD}=12\text{V}$, Freq. =50 KHz, Duty Cycle=50%, unless otherwise specified.)

Symbol	Parameter	Conditions	Min.	Typ.	Max.	Unit
SUPPLY INPUT						
I_{DD}	Supply current	Sleep mode $V_{SYNC}=0\text{V}$, V_{DD} on, No load	1.7	0.2 2.3	3.1	mA
V_{DD}	Supply voltage	I_{DD} peak < 2A			16	V
V_{DD} on	Enable voltage		7.6	8.0	8.4	V
V_{DD} hysteresis	Enable voltage			0.25	0.5	V
V_{ovp}	Over voltage protection		16	16.5	17	V
V_{ovp} hysteresis				0.35		V
SYNC REFERENCE (SYNC)						
V_{shth}	SYNC high threshold			3.2		V
V_{slth}	SYNC low threshold			0.75		V
V_{sync}	SYNC wake-up voltage	$I_{sync}=3\text{mA}$	6	6.7	7	V
I_{sync}	SYNC input current				3	mA
Voltage Regulator REFERENCE (VR)						
V_R	voltage		5.2		5.4	V
I_{VR}	VR Output Current				50	mA
ON TIME DUTY SETUP (PIN 6)						
$T_{on-time}$				4		uS
MOSFET GATE DRIVER (MOSG-C)						
V_{oh}	Output high voltage	$I_o=-200\text{mA}$	10.3	11.0		V
V_{ol}	Output low voltage	$I_o=200\text{mA}$		0.5	0.8	V
T_d	Propagation delay	No load	25	50	155	nS
T_{pred}		No load		200		nS
T_r	Rise time	Load = 1nF (*)		11	25	nS
T_f	Fall time	Load = 1nF (*)		13	25	nS
Dynamic Protect						
Dt_CCM	Dynamic variable	Pin 4 , 25K Ω to GND		500		nS
Dt_DCM	Dynamic variable	Pin 4 , 25K Ω to GND		1500		nS
T_{on-min}	MOSG-C on time	PWM adjusts time > Dt	0.4	0.6	0.8	uS

(*) T_r & T_f are measured among 10% and 90% of starting and final voltage.

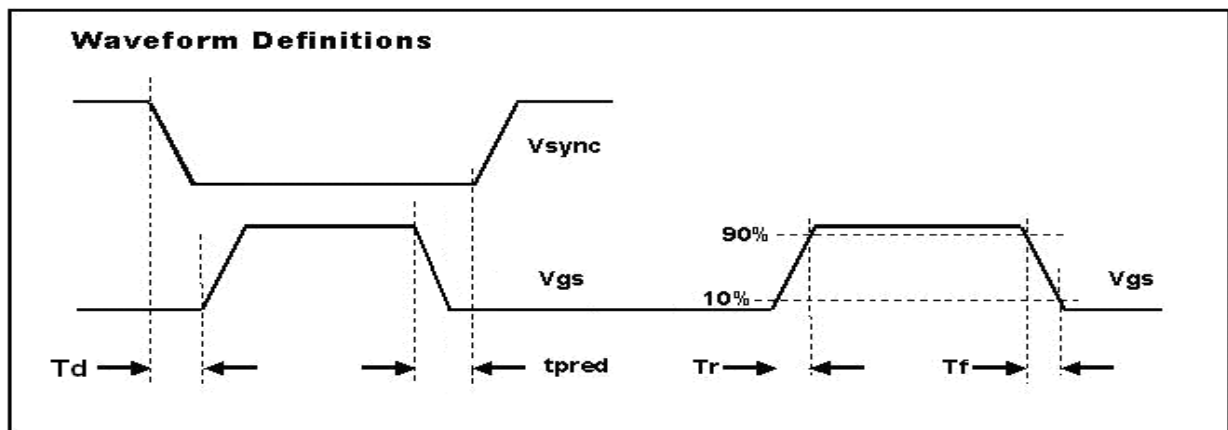



SP6052

High Frequency Synchronous Rectifier Driver

SOP-8 PACKAGE OUTLINE

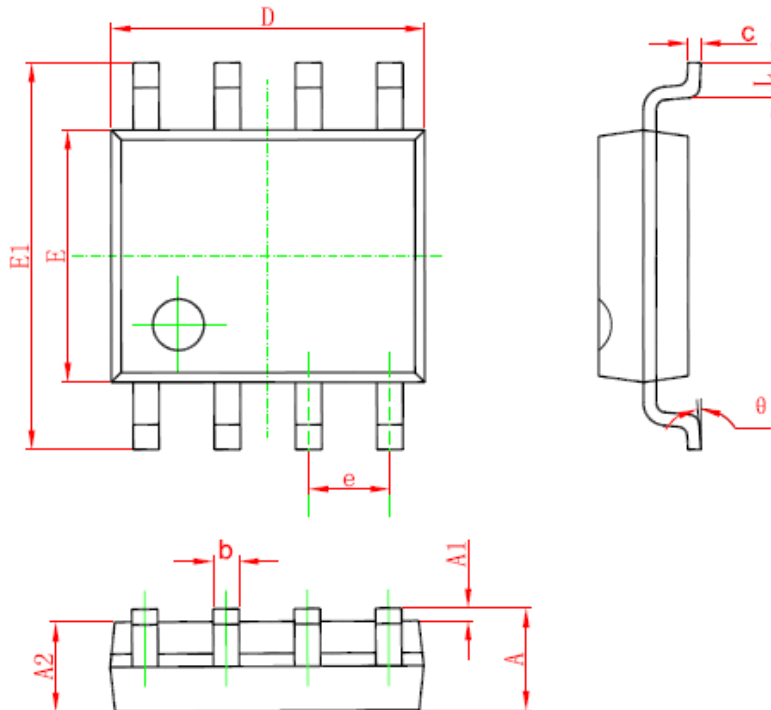

Symbol	Dimensions In Millimeters		Dimensions In Inches	
	Min	Max	Min	Max
A	1.350	1.750	0.053	0.069
A1	0.100	0.250	0.004	0.010
A2	1.350	1.550	0.053	0.061
b	0.330	0.510	0.013	0.020
c	0.170	0.250	0.006	0.010
D	4.700	5.100	0.185	0.200
E	3.800	4.000	0.150	0.157
E1	5.800	6.200	0.228	0.244
e	1.270 (BSC)		0.050 (BSC)	
L	0.400	1.270	0.016	0.050
θ	0°	8°	0°	8°



SP6052

High Frequency Synchronous Rectifier Driver

Information provided is alleged to be exact and consistent. SYNC Power Corporation presumes no responsibility for the penalties of use of such information or for any violation of patents or other rights of third parties, which may result from its use. No license is granted by allegation or otherwise under any patent or patent rights of SYNC Power Corporation. Conditions mentioned in this publication are subject to change without notice. This publication surpasses and replaces all information previously supplied. SYNC Power Corporation products are not authorized for use as critical components in life support devices or systems without express written approval of SYNC Power Corporation.

© The SYNC Power logo is a registered trademark of SYNC Power Corporation

© 2019 SYNC Power Corporation – Printed in Taiwan – All Rights Reserved

SYNC Power Corporation

7F-2, No.3-1, Park Street

NanKang District (NKSP), Taipei, Taiwan, 115, R.O.C

Phone: 886-2-2655-8178

Fax: 886-2-2655-8468

<http://www.syncpower.com>