



SP6853

Green-Mode PWM Controller

DESCRIPTION

The SP6853 is a low cost , low startup current , current mode PWM controller with green-mode power-saving operation. The integrated functions include the leading-edge blanking of the current sensing, internal slope compensation. It would provide the users a superior AC/DC power application of higher efficiency, low external component counts, and lower cost solution for applications.

The SP6853 features more protections or functions for the following characteristics :

※Add OLP (Over Load Protection) function to provide better protection performance for fault conditions like short circuit or over load.

※Modify the OVP (Over Voltage Protection) mechanism from the cycle-by-cycle mode to the hiccup mode.

SP6853 is available by SOT-23-6L / DIP-8P packages.

FEATURES

- High-Voltage BiCMOS Process
- Very Low Startup Current (<20μA)
- Under Voltage Lockout (UVLO)
- Current Mode Control
- Non-audible-noise Green Mode Control
- Current Limiting
- LEB (Leading-Edge Blanking) on CS Pin
- OLP (Over Load Protection)
- OVP (Over Voltage Protection) on Vcc Pin
- Leading-Edge Blanking
- Programmable Switching Frequency
- Internal Slope Compensation
- Green-Mode Control for Power Saving
- 300mA Driving Capability
-

APPLICATIONS

- AC/DC Switching Power Adaptor
- Battery Charger
- PC 5V Standby Power.
- Open-Frame Switching Power Supply

PIN CONFIGURATION

SOT-23-6L

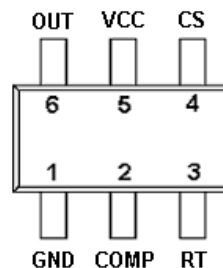

PART MARKING

SOT-23-6L

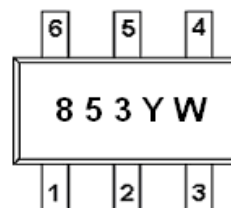

Y : Year Code
W : Week Code



SP6853 Green-Mode PWM Controller

TYPICAL APPLICATION CIRCUIT

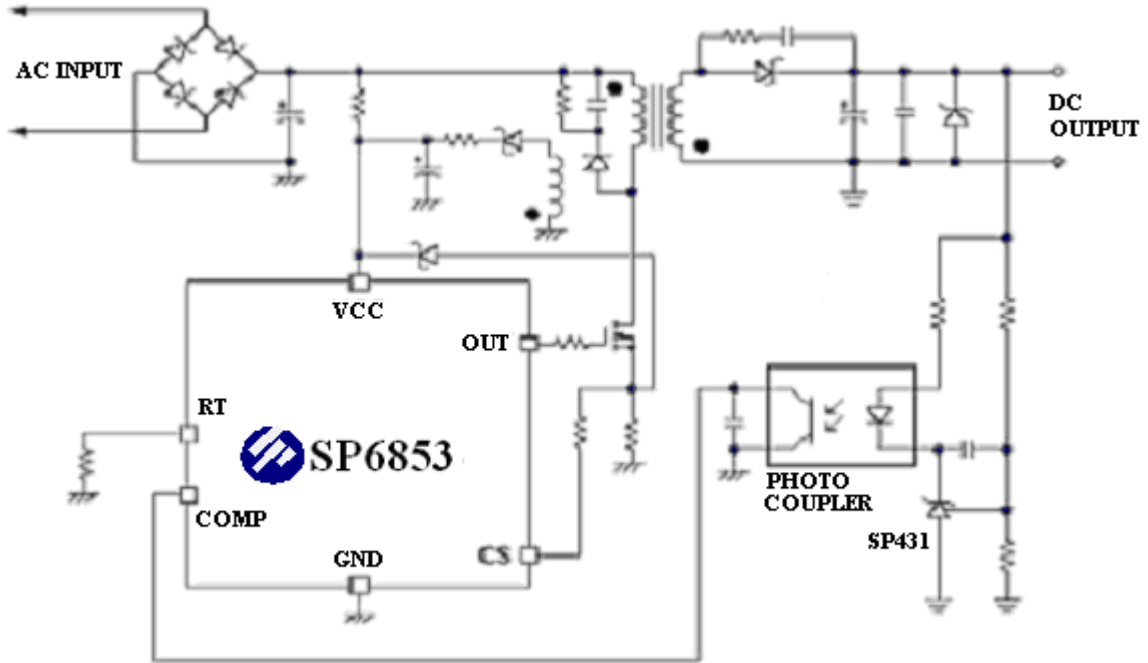

TYPICAL APPLICATION CIRCUIT (High Efficiency SMPS + Synchronous Rectifier)

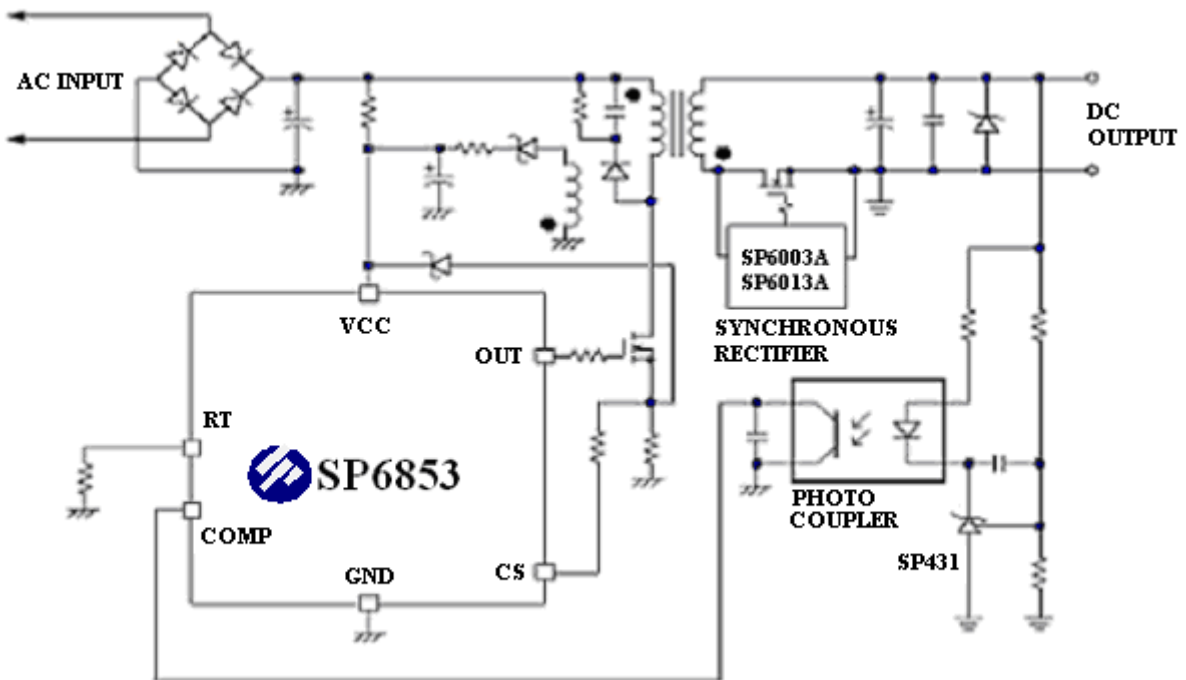



SP6853

Green-Mode PWM Controller

PIN DESCRIPTION

| Pin | Symbol | Description |
|-----|--------|--------------------------------------------------------------------------------------------------------------------------------------------------------------------------------------|
| 1 | GND | Ground |
| 2 | COMP | Voltage feedback. The pin provides the output voltage regulation signal., it provides feedback to the internal PWM comparator, so that the PWM comparator can control the duty cycle |
| 3 | RT | This current is used to charge an internal capacitor, to determine the switching frequency. |
| 4 | CS | Current sense. This pin senses the voltage across a resistor, to control PWM output. This pin also provides current amplitude information for current-mode control |
| 5 | VCC | Supply Voltage in |
| 6 | OUT | Gate driver output to drive the external MOSFET |

BLOCK DIAGRAM

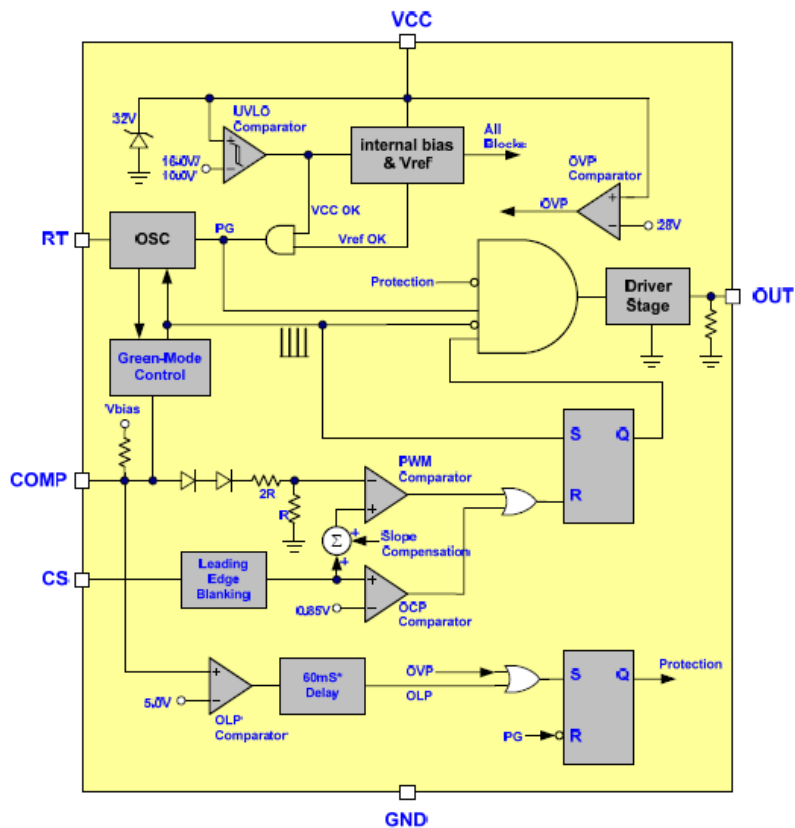

ORDERING INFORMATION

| Part Number | Package | Part Marking |
|--------------|-----------|--------------|
| SP6853S26RGB | SOT-23-6L | 853 |

※ SP6853S26RGB : Tape Reel ; Pb – Free ; Halogen-Free



SP6853

Green-Mode PWM Controller

ABSOLUTE MAXIMUM RATINGS (T_A=25°C, unless otherwise specified.)

The following ratings designate persistent limits beyond which damage to the device may occur.

| Symbol | Parameter | Value | Unit |
|-------------------------|-----------------------------------------------|------------------|------|
| V _{CC} | DC Supply Voltage | 36 | V |
| V _{COMP/RT/CS} | COMP / RT / CS Voltage | -0.3 ~ 7.0 | V |
| P _D | Power Dissipation @ T _A =85°C (*) | 0.3 | W |
| ESD | Human Body Model | 4 | KV |
| | Machine Model | 300 | V |
| T _{ope} | Operating Ambient Temperature | -40 ~ 85 | °C |
| T _J | Operating Junction Temperature Range | -40 ~ 150 | °C |
| T _{STG} | Storage Temperature Range | -40 ~ 150 | °C |
| T _{LEAD} | Pb-Free Lead Soldering Temperature for 5 sec. | 260 | °C |
| R _{θJC} | Thermal Resistance Junction – Case (*) | SOT-23-6L 210 | °C/W |

(*) The power dissipation and thermal resistance are evaluated under copper board mounted with free air conditions.



SP6853

Green-Mode PWM Controller

ELECTRICAL CHARACTERISTICS

($T_A=25^{\circ}\text{C}$, $V_{CC}=15\text{V}$, unless otherwise specified.)

| Symbol | Parameter | Conditions | Min. | Typ. | Max. | Unit |
|---------------------------------------|------------------------------------------------------|---------------------------------------------------|------|------|------|------------|
| Supply Voltage (Vcc Pin) | | | | | | |
| I _{stt} | Startup Current | | | 10 | 20 | uA |
| I _{op} | Operating Current | V _{COMP} = 0V | | 2.7 | 4 | mA |
| | | V _{COMP} = 3V | | 2.4 | | mA |
| | | Protection tripped (OLP, OVP) | | 1.0 | | mA |
| UVLO (off) | Min. Operating Voltage | | 9.0 | 10.0 | 11.0 | V |
| UVLO (on) | Start Threshold Voltage | | 15.0 | 16.0 | 17.0 | V |
| OVP Level | Over Voltage Protection | | 24 | 26 | 29.5 | V |
| Voltage Feedback (Comp Pin) | | | | | | |
| I _{sc} | Short Circuit Current | | | 1.25 | 2.2 | mA |
| V _{op} | Open Loop Voltage | | | 6 | | V |
| V _{TH(GM)} | Green Mode Threshold V _{COMP} | | | 2.35 | | V |
| Oscillator (RT Pin) | | | | | | |
| F _{osc} | Frequency | R _T =100K Ω | 60.0 | 68.0 | 75.0 | KHz |
| F _{osc(GM)} | Green Mode Frequency | F _s =65.0KHz | | 22 | | KHz |
| F _{dt} | Frequency Variation versus Temp. Deviation | (-40 $^{\circ}\text{C}$ ~105 $^{\circ}\text{C}$) | | | 3 | % |
| F _{dv} | Frequency Variation versus V _{CC} Deviation | (V _{CC} =11V-25V) | | | 1 | % |
| Current Sensing (CS Pin) | | | | | | |
| V _{cs(off)} | Maximum Input Voltage | | 0.8 | 0.85 | 0.9 | V |
| T _{LEDD} | Leading Edge Blanking Time | | | 280 | | nS |
| Z _{cs} | Input impedance | | 1 | | | M Ω |
| T _{PD} | Delay to Output | | | 100 | | nS |
| Gate Driver Output (OUT Pin) | | | | | | |
| DC (Max) | Maximum Duty Cycle | | 70 | 75 | 80 | % |
| DC (Min) | Minimum Duty Cycle | | | 0 | | % |
| V _{OL} | Output Low Level | V _{CC} =15V, I _o =20mA | | | 1 | V |
| V _{OH} | Output High Level | V _{CC} =15V, I _o =20mA | 8 | | | V |
| T _r | Rising Time | Load Cap=1000pF | | 50 | 200 | nS |
| T _f | Falling Time | Load Cap=1000pF | | 30 | 120 | nS |
| OLP (Over Load Protection) | | | | | | |
| T _{LOLP} | OLP Trip Level | | | 5.0 | | V |
| T _{DOLP} | OLP Delay Time (note) | | | 60 | | mS |

Note: The OLP delay time is proportional to the period of switching cycle. So that, the lower RT value will set the higher switching frequency and the shorter OLP delay time.



SP6853 Green-Mode PWM Controller

PERFORMANCE CHARACTERISTICS ($T_A=25^{\circ}\text{C}$, unless otherwise specified.)

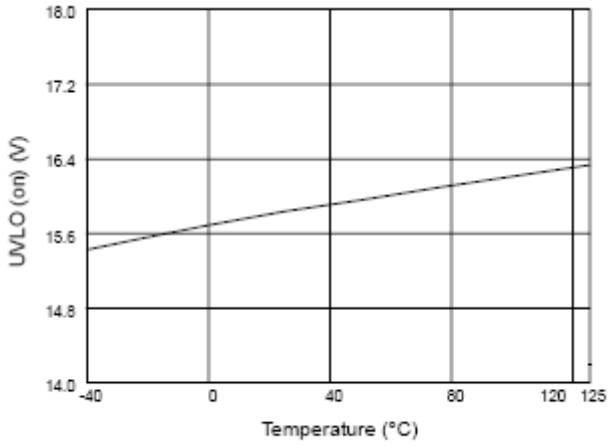

Fig. 1 UVLO (on) vs. Temperature

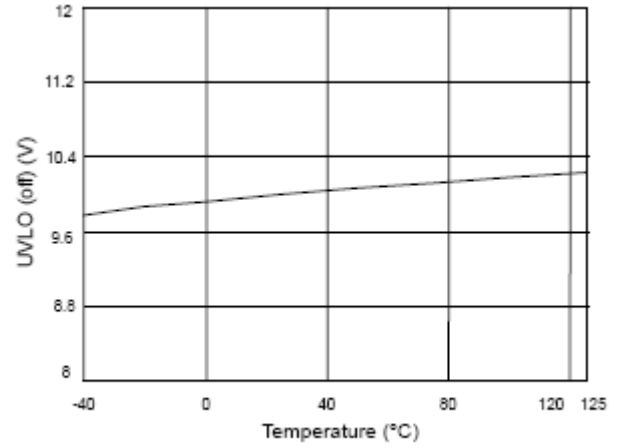

Fig. 2 UVLO (off) vs. Temperature

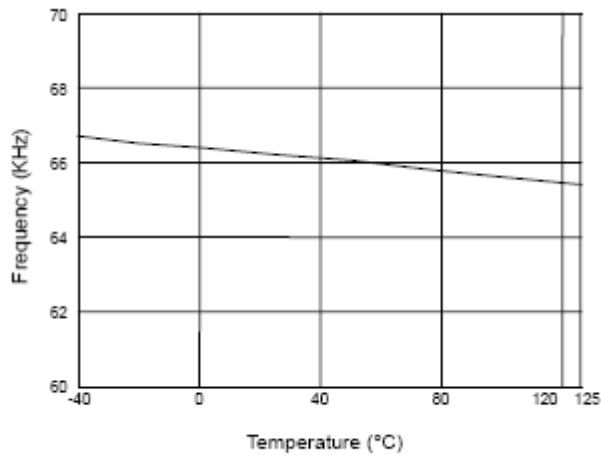

Fig. 3 Frequency vs. Temperature

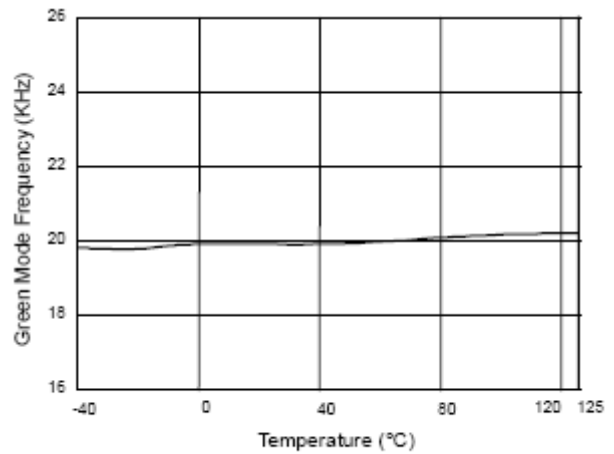

Fig. 4 Green Mode Frequency vs. Temperature

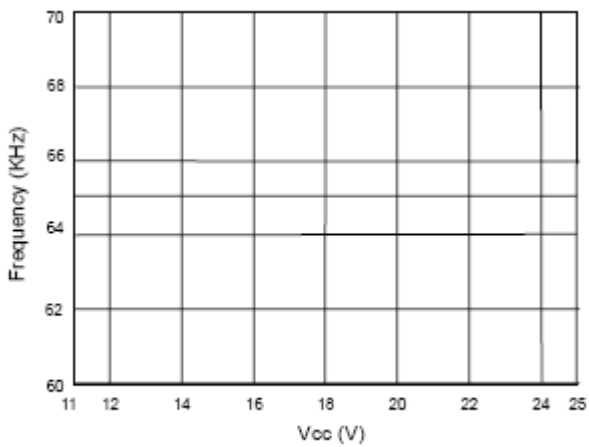

Fig. 5 Frequency vs. Vcc

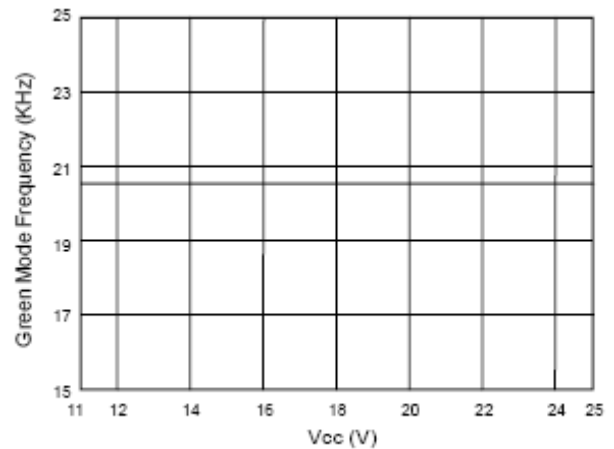

Fig. 6 Green Mode Frequency vs. Vcc



SP6853 Green-Mode PWM Controller

PERFORMANCE CHARACTERISTICS ($T_A=25^\circ\text{C}$, unless otherwise specified.)

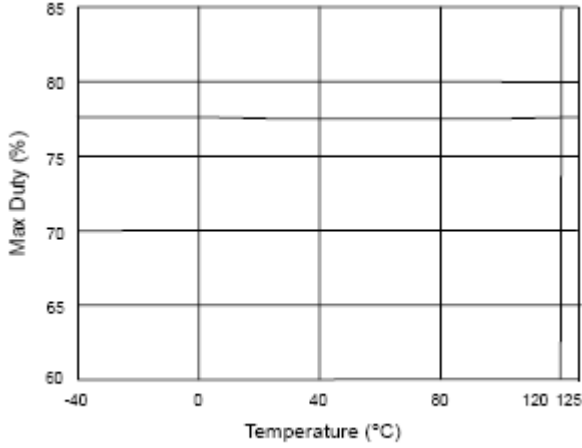

Fig. 7 Max Duty vs. Temperature

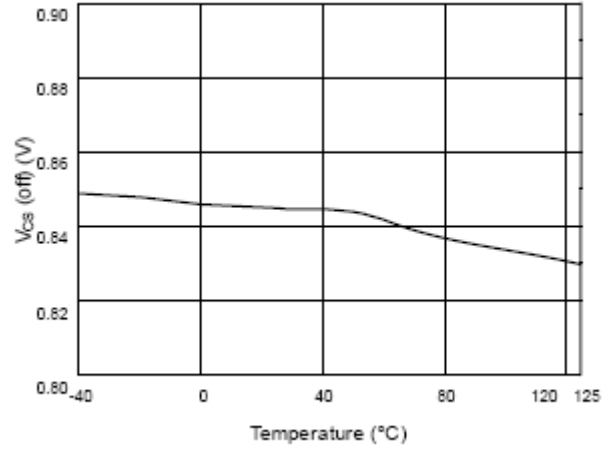

Fig. 8 $V_{CS}(\text{off})$ vs. Temperature

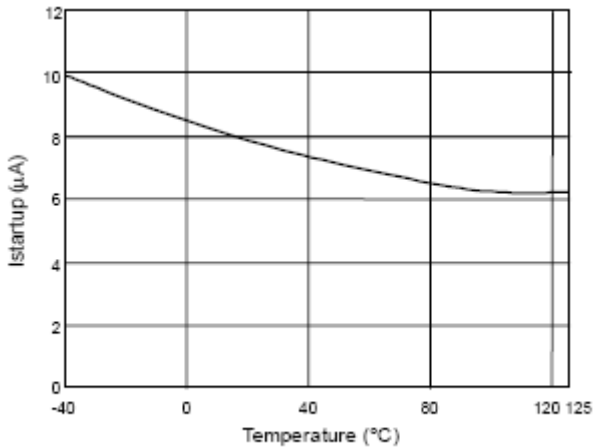

Fig. 9 Startup Current (I_{startup}) vs. Temperature

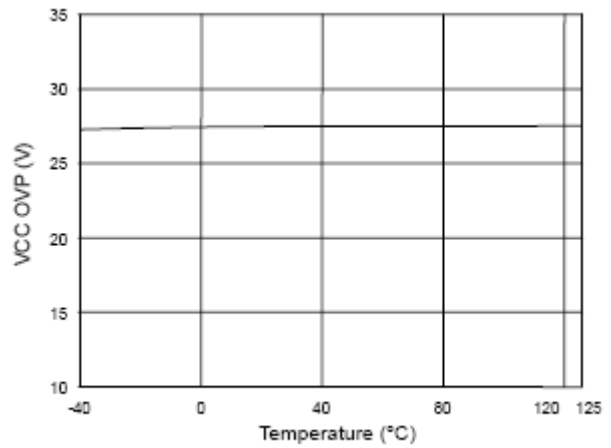

Fig. 10 VCC OVP vs. Temperature

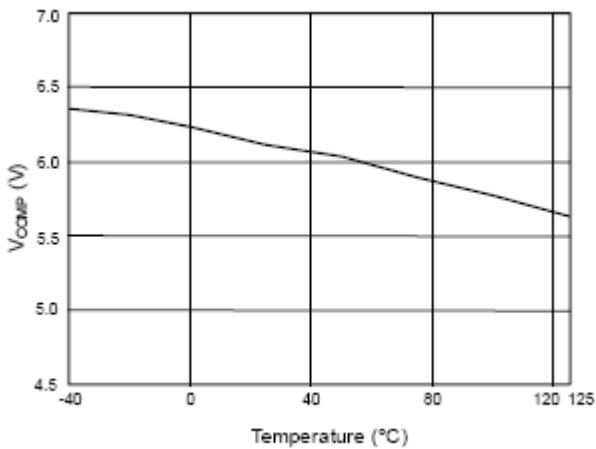

Fig. 11 V_{comp} open loop voltage vs. Temperature

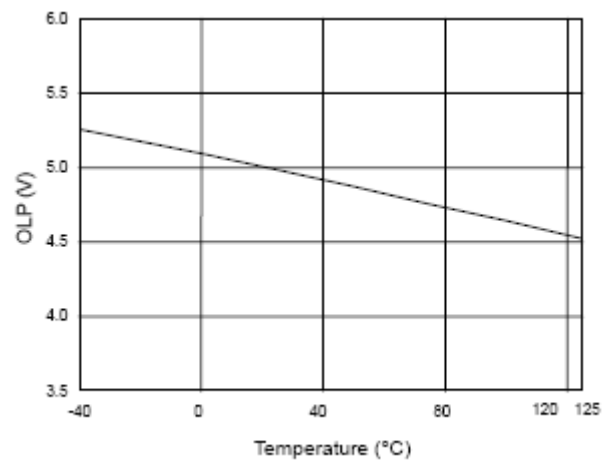
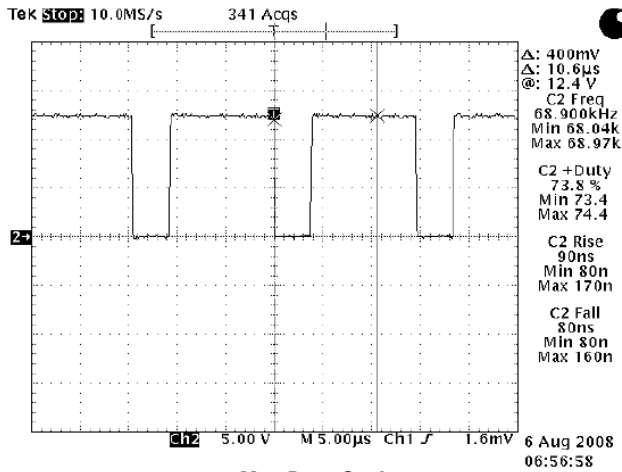

Fig. 12 OLP-Trip Level vs. Temperature



SP6853 Green-Mode PWM Controller

PERFORMANCE CHARACTERISTICS ($T_A=25^{\circ}\text{C}$, unless otherwise specified.)



Max Duty Cycle

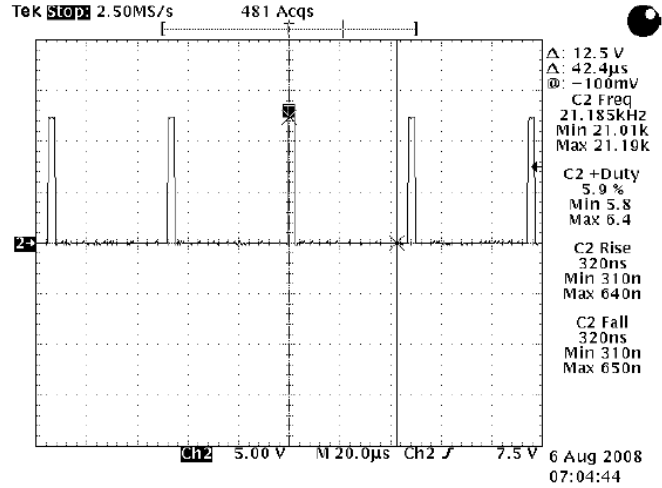

Min Duty Cycle

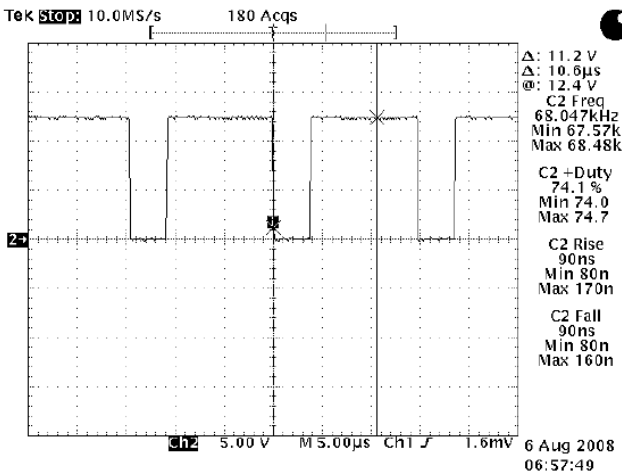

Max Duty Cycle

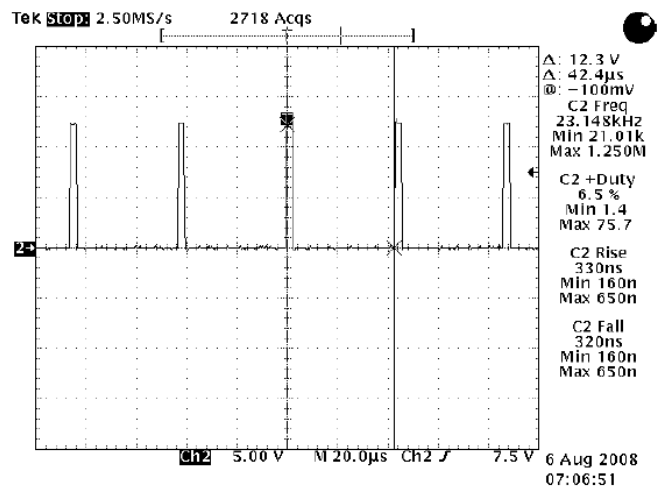

Min Duty Cycle

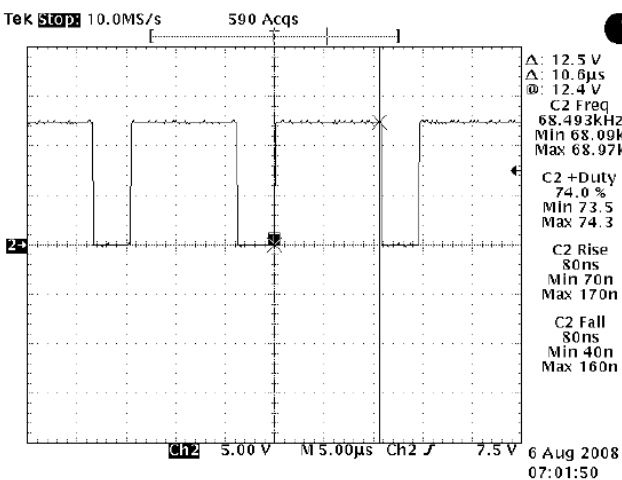

Max Duty Cycle

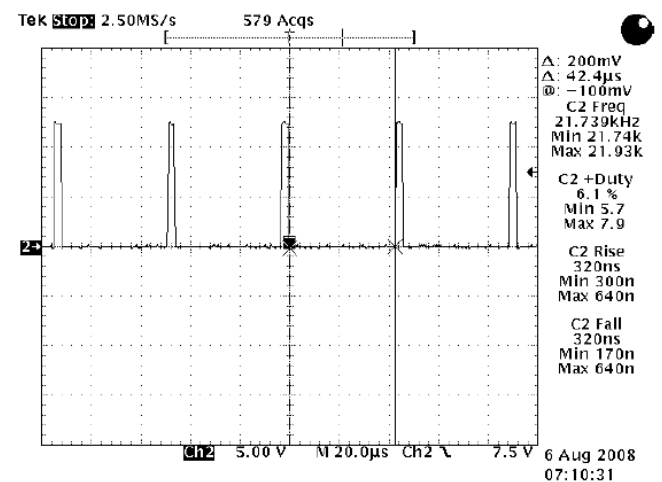

Min Duty Cycle



SP6853 Green-Mode PWM Controller

PERFORMANCE CHARACTERISTICS ($T_A=25^{\circ}\text{C}$, unless otherwise specified.)

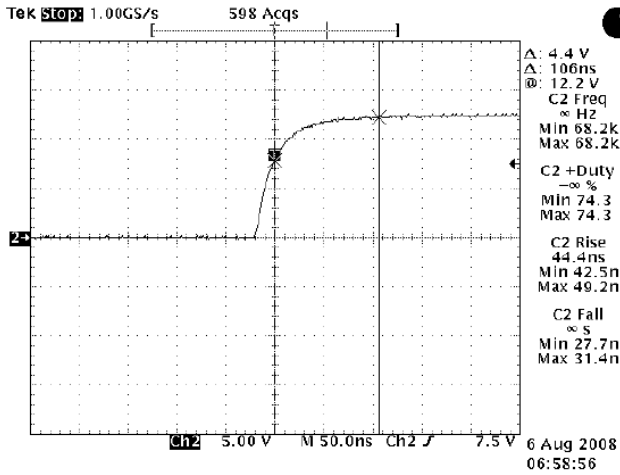

Rising Time Load

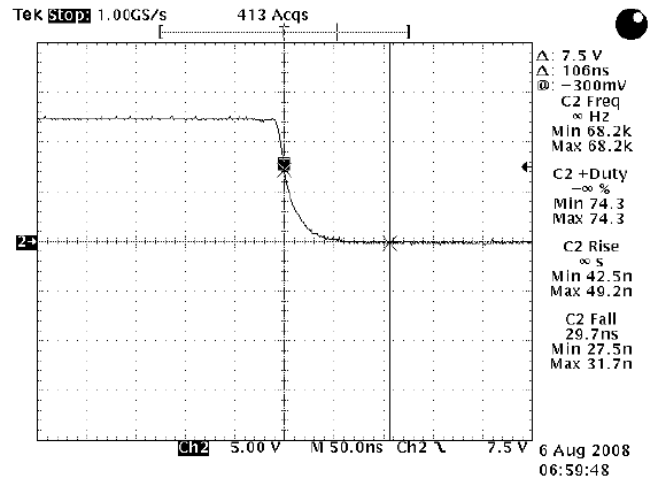

Falling Time Load

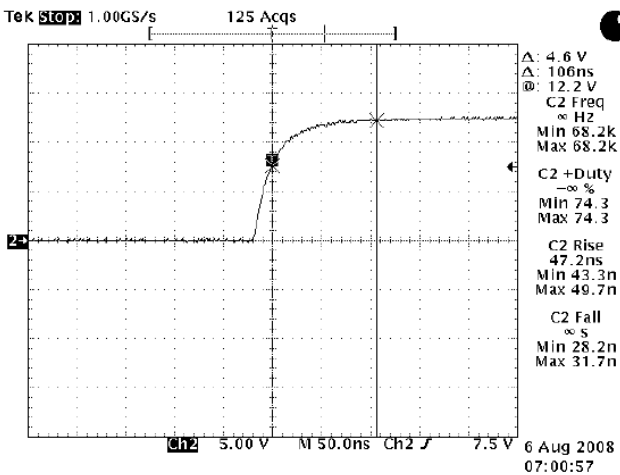

Rising Time Load

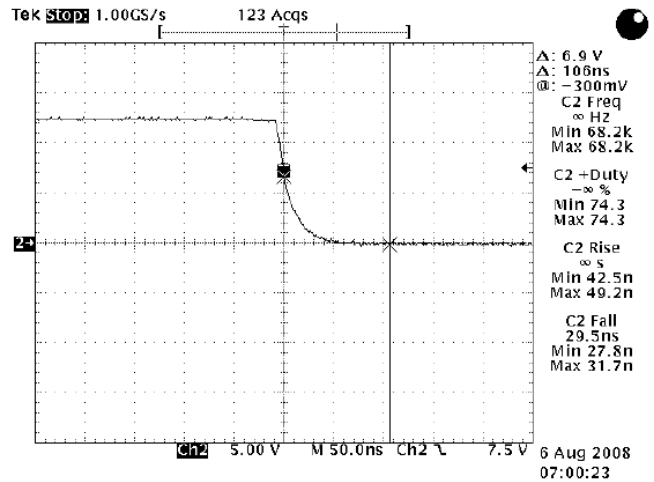

Falling Time Load

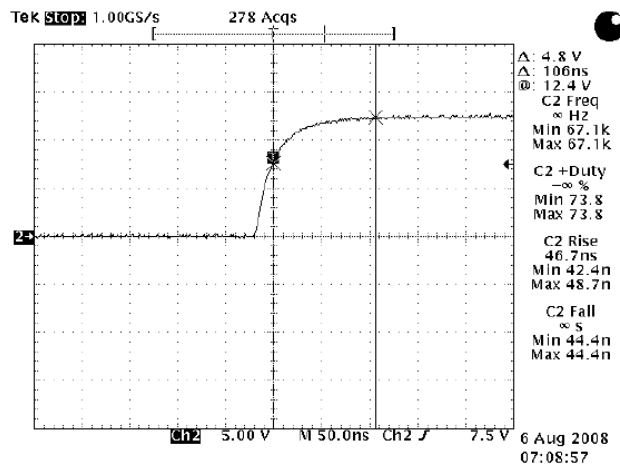

Rising Time Load

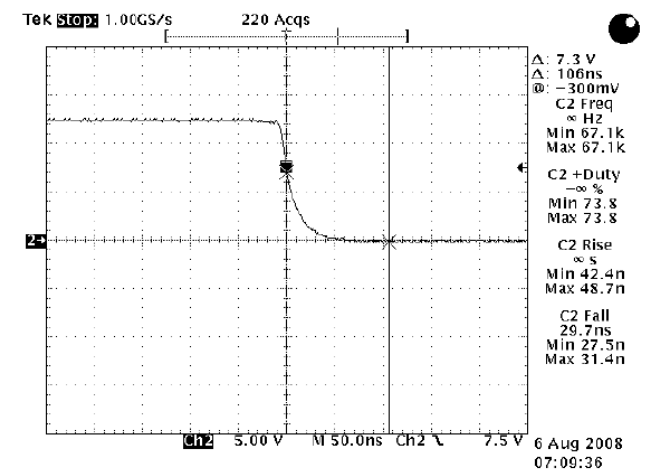

Falling Time Load



SP6853 Green-Mode PWM Controller

PERFORMANCE CHARACTERISTICS ($T_A=25^\circ\text{C}$, unless otherwise specified.)

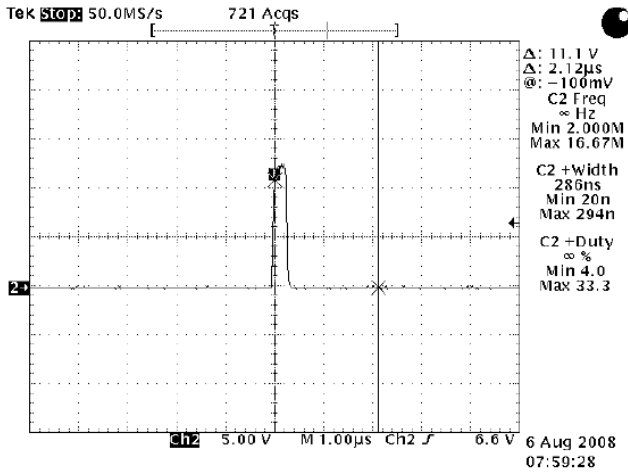

Leading Edge Blanking Time

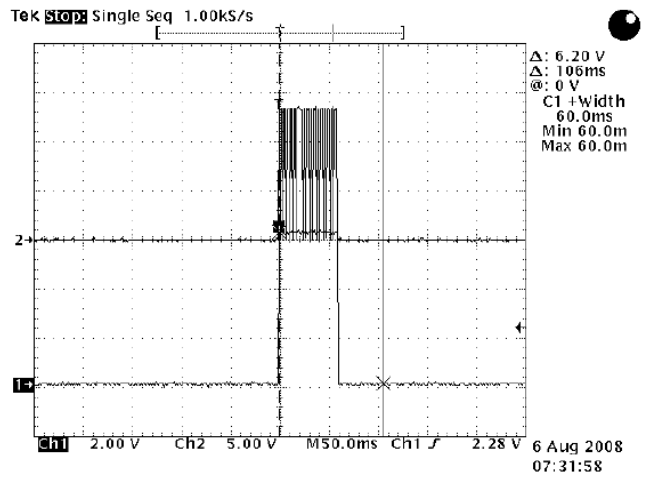

OLP Delay Time

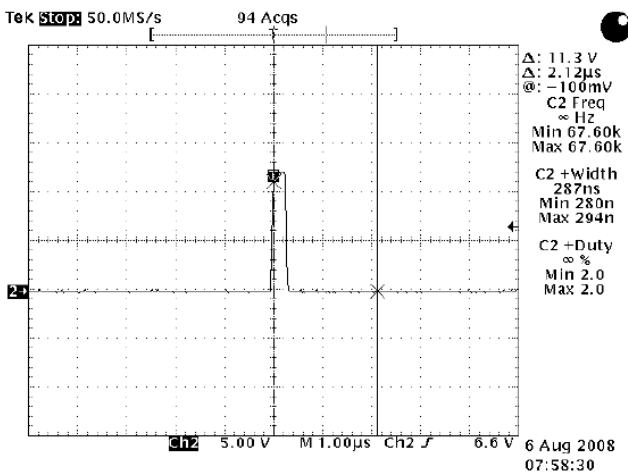

Leading Edge Blanking Time

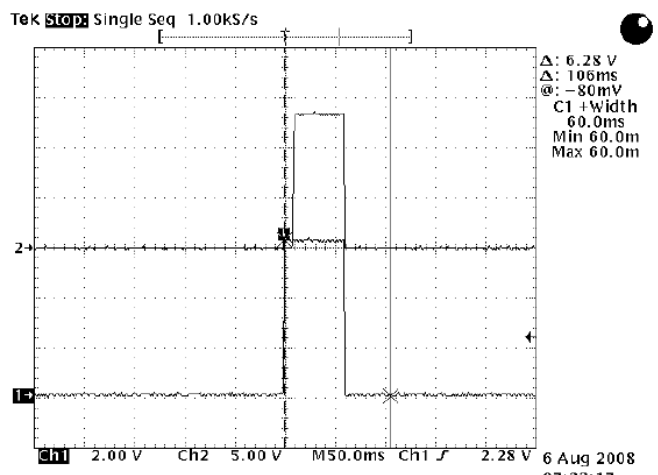

OLP Delay Time

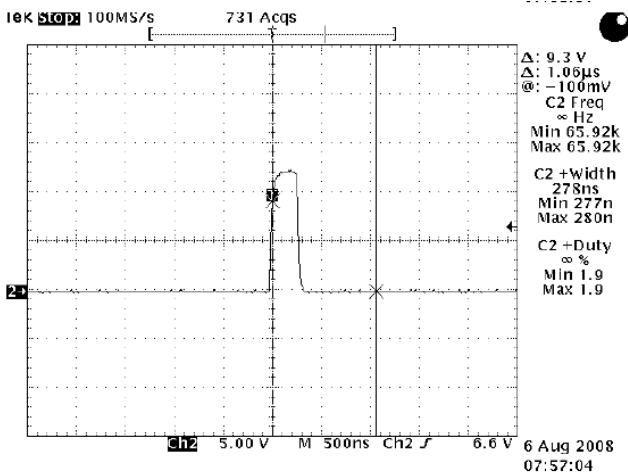

Leading Edge Blanking Time

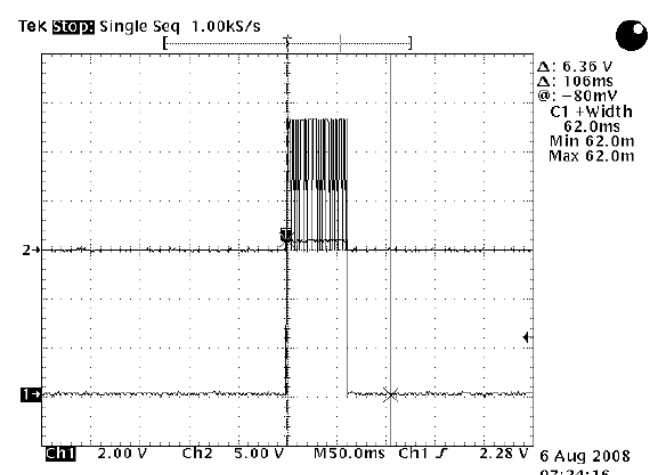

OLP Delay Time



SP6853

Green-Mode PWM Controller

Information provided is alleged to be exact and consistent. SYNC Power Corporation presumes no responsibility for the penalties of use of such information or for any violation of patents or other rights of third parties that may result from its use. No license is granted by allegation or otherwise under any patent or patent rights of SYNC Power Corporation. Conditions mentioned in this publication are subject to change without notice. This publication surpasses and replaces all information previously supplied. SYNC Power Corporation products are not authorized for use as critical components in life support devices or systems without express written approval of SYNC Power Corporation.

© The SYNC Power logo is a registered trademark of SYNC Power Corporation

© 2020 SYNC Power Corporation – Printed in Taiwan – All Rights Reserved

SYNC Power Corporation

7F-2, No.3-1, Park Street

NanKang District (NKSP), Taipei, Taiwan, 115, R.O.C

Phone: 886-2-2655-8178

Fax: 886-2-2655-8468

<http://www.syncpower.com>