



SPN4862

N-Channel Enhancement Mode MOSFET

DESCRIPTION

The SPN4862 is the N-Channel logic enhancement mode power field effect transistors are produced using high cell density , DMOS trench technology.

This high density process is especially tailored to minimize on-state resistance.

These devices are particularly suited for low voltage application , notebook computer power management and other battery powered circuits where high-side switching .

FEATURES

- ◆ 60V/15A, $R_{DS(ON)}=10m\Omega@V_{GS}=10V$
- ◆ 60V/10A, $R_{DS(ON)}=12m\Omega@V_{GS}=4.5V$
- ◆ Super high density cell design for extremely low $R_{DS(ON)}$
- ◆ Exceptional on-resistance and maximum DC current capability
- ◆ SOP – 8P package design

APPLICATIONS

- DC/DC Converter
- Load Switch
- Synchronous Buck Converter

PIN CONFIGURATION(SOP – 8P)

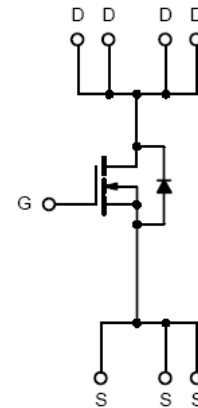
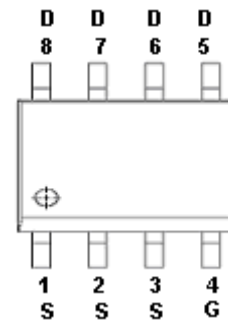

PART MARKING





SPN4862

N-Channel Enhancement Mode MOSFET

PIN DESCRIPTION

Pin	Symbol	Description
1	S	Source
2	S	Source
3	S	Source
4	G	Gate
5	D	Drain
6	D	Drain
7	D	Drain
8	D	Drain

ORDERING INFORMATION

Part Number	Package	Part Marking
SPN4862S8RGB	SOP-8P	SPN4862

※ SPN4862S8RGB : 13" Tape Reel ; Pb – Free ; Halogen – Free

ABSOLUTE MAXIMUM RATINGS

(TA=25°C Unless otherwise noted)

Parameter	Symbol	Typical	Unit
Drain-Source Voltage	V _{DSS}	60	V
Gate –Source Voltage	V _{GSS}	±20	V
Continuous Drain Current(T _J =150°C)	I _D	TA=25°C	10
		TA=70°C	7
Pulsed Drain Current	I _{DM}	60	A
Avalanche Current	I _{AS}	38	A
Power Dissipation	P _D	TA=25°C	2.5
		TA=70°C	1.6
Operating Junction Temperature	T _J	-55/150	°C
Storage Temperature Range	T _{STG}	-55/150	°C
Thermal Resistance-Junction to Ambient	R _{θJA}	80	°C/W



SPN4862

N-Channel Enhancement Mode MOSFET

ELECTRICAL CHARACTERISTICS

(TA=25°C Unless otherwise noted)

Parameter	Symbol	Conditions	Min.	Typ	Max.	Unit
Static						
Drain-Source Breakdown Voltage	$V_{(BR)DSS}$	$V_{GS}=0V, I_D=250\mu A$	60			V
Gate Threshold Voltage	$V_{GS(th)}$	$V_{DS}=V_{GS}, I_D=250\mu A$	1.0		2.5	
Gate Leakage Current	I_{GSS}	$V_{DS}=0V, V_{GS}=\pm 20V$			± 100	nA
Zero Gate Voltage Drain Current	I_{DSS}	$V_{DS}=48V, V_{GS}=0V$			1	uA
		$V_{DS}=48V, V_{GS}=0V$ $T_J=55^\circ C$			5	
On-State Drain Current	$I_{D(on)}$	$V_{DS}\geq 5V, V_{GS}=10V$	60			A
Drain-Source On-Resistance	$R_{DS(on)}$	$V_{GS}=10V, I_D=15A$		10	12	mΩ
		$V_{GS}=4.5V, I_D=10A$		12	15	
Forward Transconductance	g_{fs}	$V_{DS}=5V, I_D=15A$		47		S
Diode Forward Voltage	V_{SD}	$I_S=60A, V_{GS}=0V$			1.2	V
Dynamic						
Total Gate Charge	Q_g	$V_{DS}=48V, V_{GS}=4.5V$ $I_D=12A$		24		nC
Gate-Source Charge	Q_{gs}			6.9		
Gate-Drain Charge	Q_{gd}			10		
Input Capacitance	C_{iss}	$V_{DS}=15V, V_{GS}=0V$ $f=1MHz$		3200		pF
Output Capacitance	C_{oss}			210		
Reverse Transfer Capacitance	C_{rss}			145		
Turn-On Time	$t_{d(on)}$	$V_{DD}=30V,$ $I_D=2A, V_{GEN}=10V$ $R_G=3.3\Omega$		20		nS
	t_r			4		
Turn-Off Time	$t_{d(off)}$			84.5		
	t_f			6.5		



SPN4862 N-Channel Enhancement Mode MOSFET

TYPICAL CHARACTERISTICS

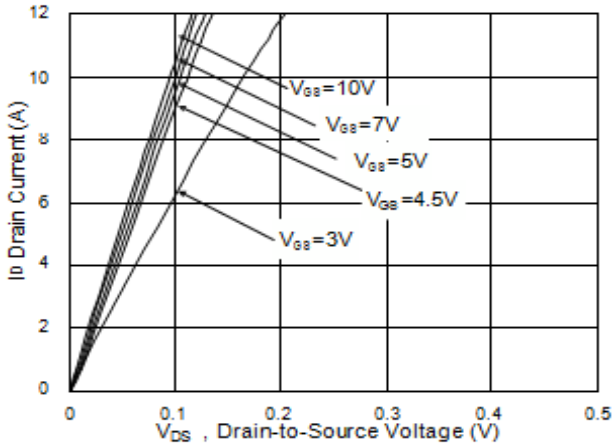

Fig. 1 Typical Output Characteristics

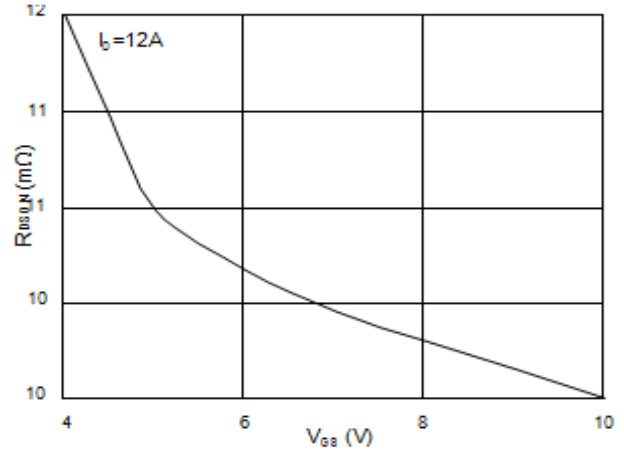

Fig. 2 On-Resistance vs. Gate Voltage

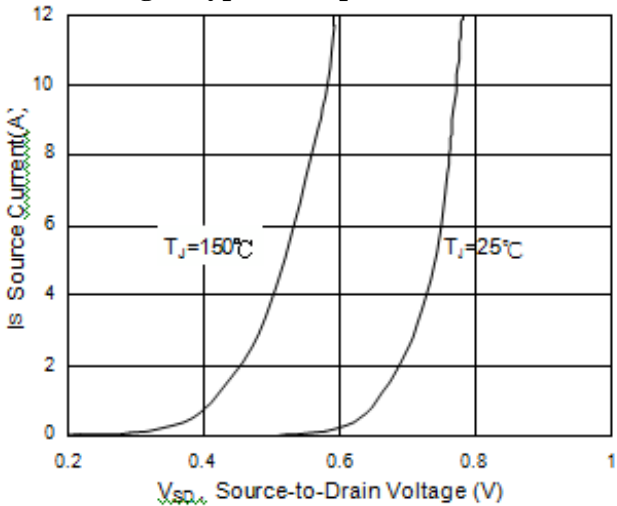

Fig. 3 Forward Characteristics
Reverse Diodes

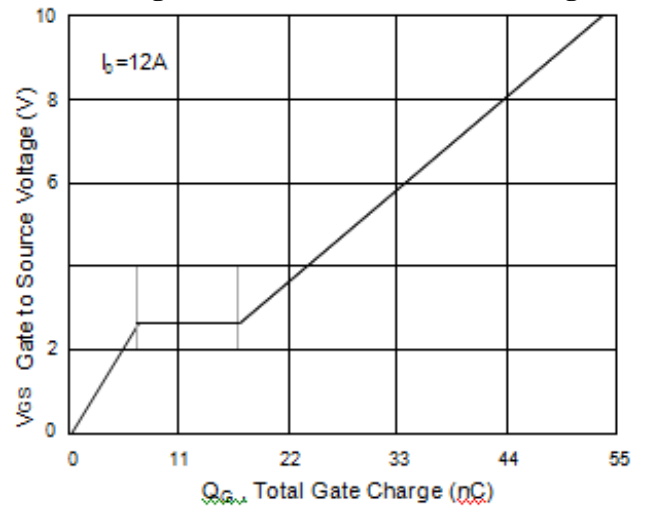

Fig. 4 Gate Charge Characteristics

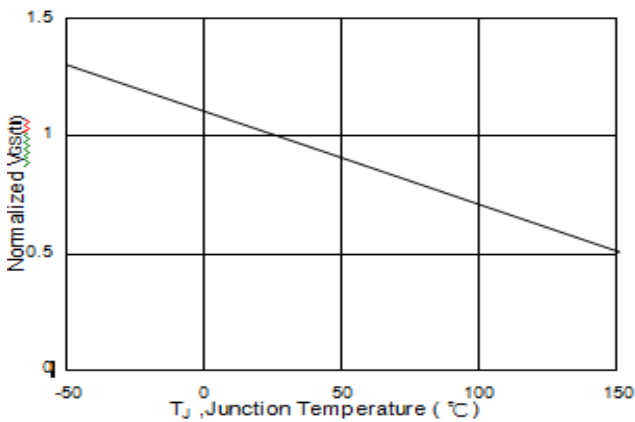

Fig. 5 Vgs vs. Junction Temperature

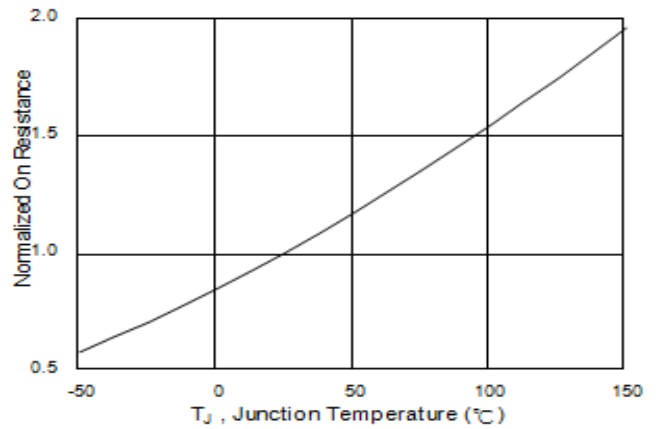

Fig. 6 On-Resistance vs. Temperature



SPN4862 N-Channel Enhancement Mode MOSFET

TYPICAL CHARACTERISTICS

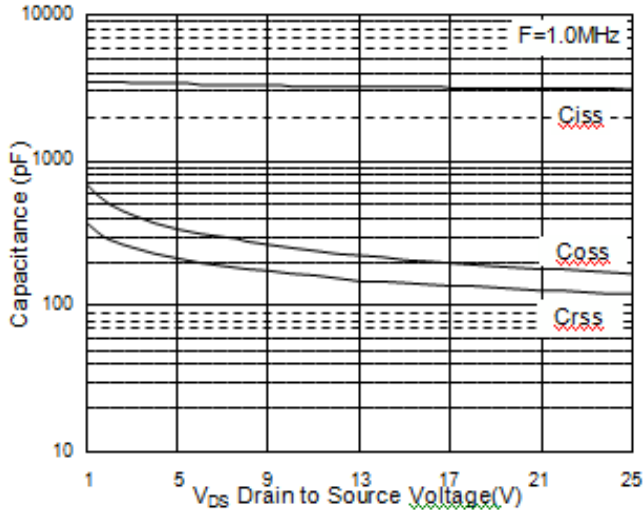

Fig. 7 Typical Capacitance Characteristics

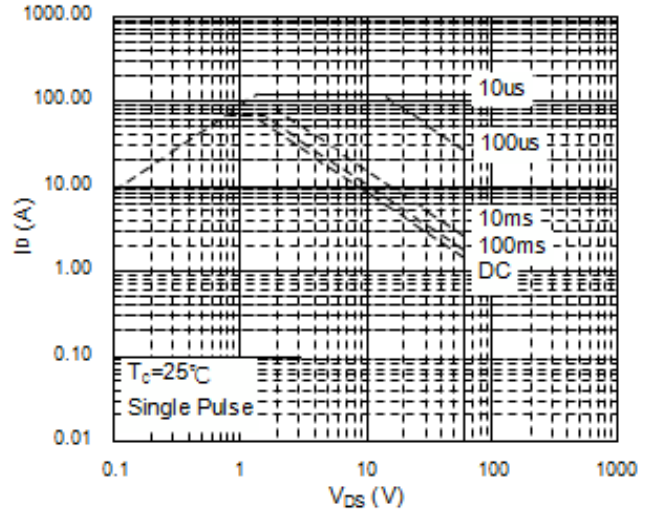

Fig. 8 Maximum Safe Operation Area

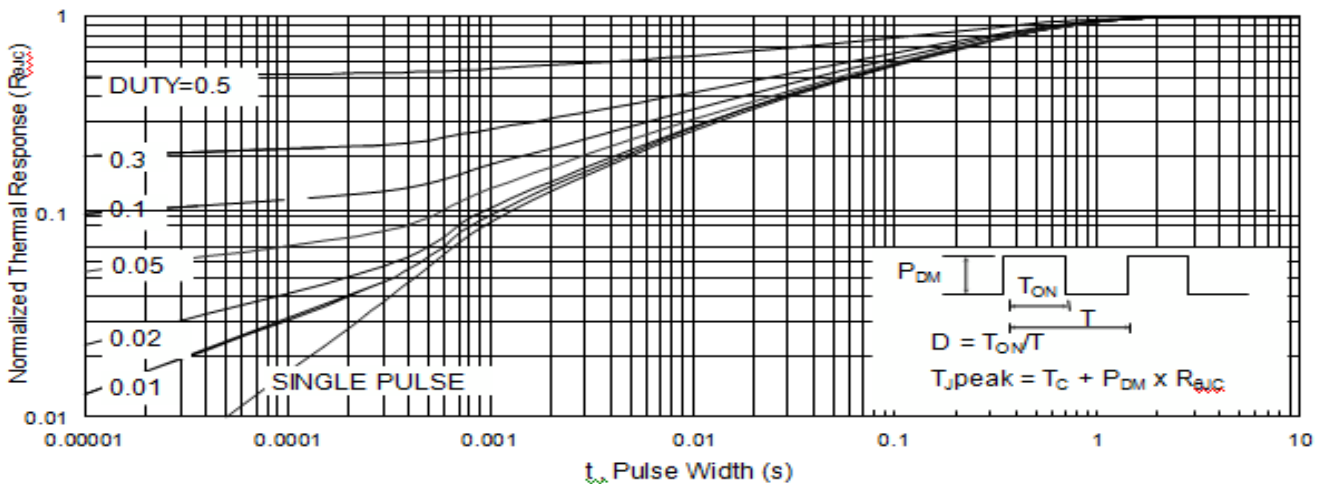

Fig. 9 Effective Transient Thermal Impedance

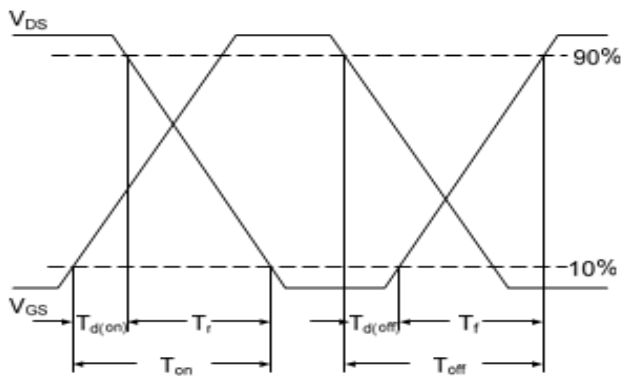

Fig. 10 Switching Time Waveform

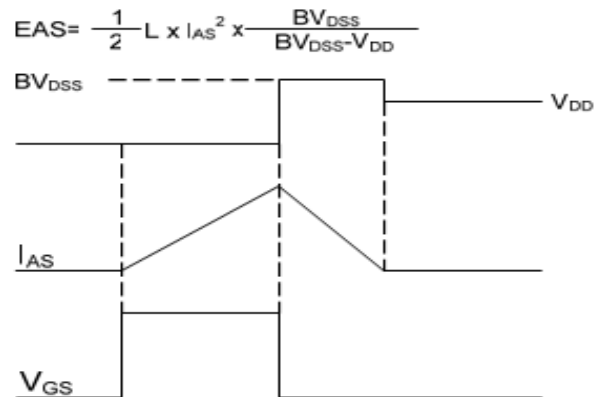

Fig. 11 Unclamped Inductive Waveform



SPN4862

N-Channel Enhancement Mode MOSFET

SOP- 8 PACKAGE OUTLINE

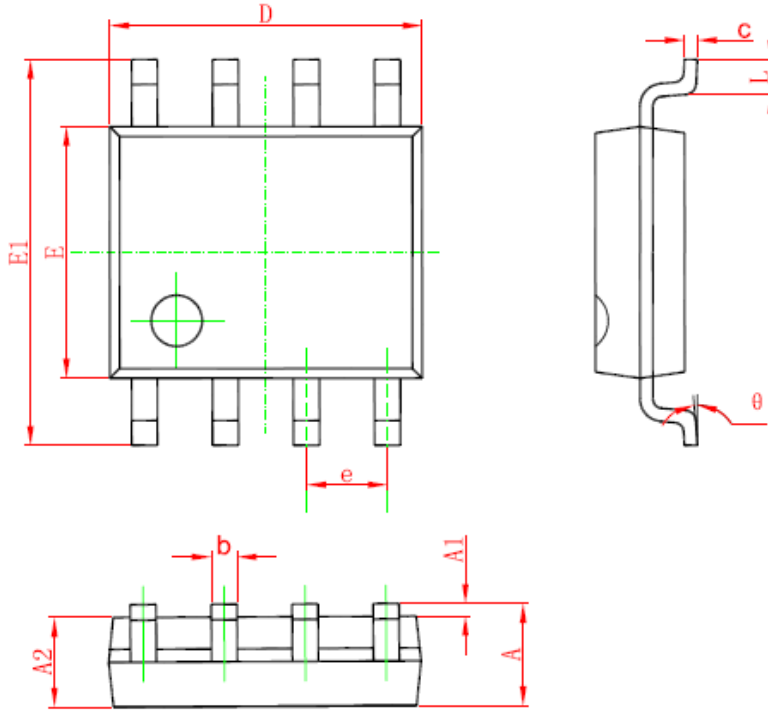

Symbol	Dimensions In Millimeters		Dimensions In Inches	
	Min	Max	Min	Max
A	1.350	1.750	0.053	0.069
A1	0.100	0.250	0.004	0.010
A2	1.350	1.550	0.053	0.061
b	0.330	0.510	0.013	0.020
c	0.170	0.250	0.006	0.010
D	4.700	5.100	0.185	0.200
E	3.800	4.000	0.150	0.157
E1	5.800	6.200	0.228	0.244
e	1.270 (BSC)		0.050 (BSC)	
L	0.400	1.270	0.016	0.050
θ	0°	8°	0°	8°



SPN4862

N-Channel Enhancement Mode MOSFET

Information provided is alleged to be exact and consistent. SYNC Power Corporation presumes no responsibility for the penalties of use of such information or for any violation of patents or other rights of third parties which may result from its use. No license is granted by allegation or otherwise under any patent or patent rights of SYNC Power Corporation. Conditions mentioned in this publication are subject to change without notice. This publication surpasses and replaces all information previously supplied. SYNC Power Corporation products are not authorized for use as critical components in life support devices or systems without express written approval of SYNC Power Corporation.

© The SYNC Power logo is a registered trademark of SYNC Power Corporation

© 2016 SYNC Power Corporation – Printed in Taiwan – All Rights Reserved

SYNC Power Corporation

7F-2, No.3-1, Park Street

NanKang District (NKSP), Taipei, Taiwan 115

Phone: 886-2-2655-8178

Fax: 886-2-2655-8468

© <http://www.syncpower.com>