



# SPN7002L

## N-Channel Enhancement Mode MOSFET

### DESCRIPTION

The SPN7002L is the N-Channel enhancement mode field effect transistors are produced using high cell density DMOS technology. These products have been designed to minimize on-state resistance while provide rugged, reliable, and fast switching performance. They can be used in most applications requiring up to 300mA DC and can deliver pulsed currents up to 0.8A. These products are particularly suited for low voltage, low current applications such as small servo motor control, power MOSFET gate drivers, and other switching applications.

### FEATURES

- ◆ 50V/0.30A ,  $R_{DS(ON)} = 3.5\Omega @ V_{GS} = 10V$
- ◆ 50V/0.25A ,  $R_{DS(ON)} = 5.5\Omega @ V_{GS} = 4.5V$
- ◆ 50V/0.05A ,  $R_{DS(ON)} = 7.5\Omega @ V_{GS} = 2.5V$
- ◆ Super high density cell design for extremely low  $R_{DS(ON)}$
- ◆ Exceptional on-resistance and maximum DC current capability
- ◆ SOT-23 package design

### APPLICATIONS

- Drivers: Relays, Solenoids, Lamps, Hammers, Display, Memories, Transistors, etc.
- High saturation current capability. Direct Logic-Level Interface: TTL/CMOS
- Battery Operated Systems
- Solid-State Relays

### PIN CONFIGURATION(SOT-23)

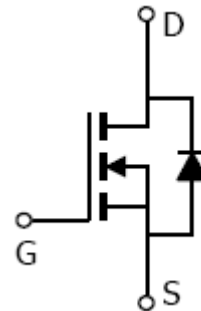
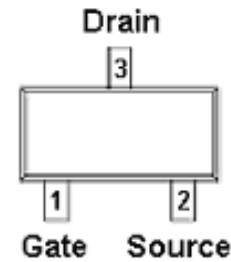

### PART MARKING

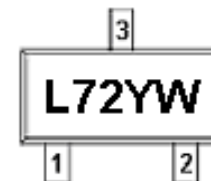

**Y : Year Code**  
**W : Week Code**



# SPN7002L

## N-Channel Enhancement Mode MOSFET

### PIN DESCRIPTION

Pin	Symbol	Description
1	G	Gate
2	S	Source
3	D	Drain

### ORDERING INFORMATION

Part Number	Package	Part Marking
SPN7002LS23RGB	SOT-23	L72YW

※ Week Code : A ~ Z ( 1 ~ 26 ) ; a ~ z ( 27 ~ 52 )

※ SPN7002LS23RGB : Tape Reel ; Pb – Free; Halogen – Free

### ABSOLUTE MAXIMUM RATINGS (TA=25°C Unless otherwise noted)

Parameter	Symbol	Typical	Unit
Drain-Source Voltage	V <sub>DSS</sub>	50	V
Gate –Source Voltage - Continuous	V <sub>GSS</sub>	±20	V
Gate –Source Voltage - Non Repetitive ( t <sub>p</sub> < 50μs)	V <sub>GSS</sub>	±40	V
Continuous Drain Current(T <sub>J</sub> =150°C)	I <sub>D</sub>	0.3	A
Pulsed Drain Current (*)	I <sub>DM</sub>	0.8	A
Power Dissipation	P <sub>D</sub>	0.35	W
Operating Junction Temperature	T <sub>J</sub>	-55 ~ 150	°C
Storage Temperature Range	T <sub>STG</sub>	-55 ~ 150	°C
Thermal Resistance-Junction to Ambient	R <sub>θJA</sub>	375	°C/W

(\*) Pulse width limited by safe operating area



# SPN7002L

## N-Channel Enhancement Mode MOSFET

### ELECTRICAL CHARACTERISTICS (T<sub>A</sub>=25°C Unless otherwise noted)

Parameter	Symbol	Conditions	Min.	Typ	Max.	Unit
<b>Static</b>						
Drain-Source Breakdown Voltage	V <sub>(BR)DSS</sub>	V <sub>GS</sub> =0V, I <sub>D</sub> =250μA	50			V
Gate Threshold Voltage	V <sub>GS(th)</sub>	V <sub>DS</sub> =V <sub>GS</sub> , I <sub>D</sub> =250μA	0.8	1.25	1.5	
Gate Leakage Current	I <sub>GSS</sub>	V <sub>DS</sub> =0V, V <sub>GS</sub> =±20V			±100	nA
Zero Gate Voltage Drain Current	I <sub>DSS</sub>	V <sub>DS</sub> =45V, V <sub>GS</sub> =0V			1	μA
		V <sub>DS</sub> =45V, V <sub>GS</sub> =0V T <sub>J</sub> =125°C			10	
Drain-Source On-Resistance	R <sub>DSON</sub>	V <sub>GS</sub> =10V, I <sub>D</sub> =0.30A		2.5	3.5	Ω
		V <sub>GS</sub> = 4.5V, I <sub>D</sub> =0.25A		3.3	5.5	
		V <sub>GS</sub> = 2.5V, I <sub>D</sub> =0.05A		5.0	7.5	
Source-drain Current	I <sub>SD</sub>				0.35	A
Source-drain Current (pulsed)	I <sub>SDM</sub> (2)				1.4	A
Forward Transconductance	G <sub>fs</sub> (1)	V <sub>DS</sub> = 10 V, I <sub>D</sub> = 0.5 A		0.6		S
Diode Forward Voltage	V <sub>SD</sub> (1)	V <sub>GS</sub> = 0 V, I <sub>S</sub> = 0.12A		0.85	1.5	V
<b>Dynamic</b>						
Total Gate Charge	Q <sub>g</sub>	V <sub>DD</sub> = 30 V, I <sub>D</sub> = 1 A, V <sub>GS</sub> = 5 V		1.4	2.0	nC
Gate-Source Charge	Q <sub>gs</sub>			0.8		
Gate-Drain Charge	Q <sub>gd</sub>			0.5		
Input Capacitance	C <sub>iss</sub>	V <sub>DS</sub> = 25 V, f = 1 MHz, V <sub>GS</sub> = 0		43		pF
Output Capacitance	C <sub>oss</sub>			20		
Reverse Transfer Capacitance	C <sub>rss</sub>			6		
Turn-On Time	t <sub>d(on)</sub>	V <sub>DD</sub> = 30 V, I <sub>D</sub> = 0.5 A R <sub>G</sub> = 4.7Ω V <sub>GS</sub> = 4.5 V		5		ns
	t <sub>r</sub>			15		
Turn-Off Time	t <sub>d(off)</sub>			7		
	t <sub>f</sub>			8		

(1) Pulsed: Pulse duration = 300 μs, duty cycle 1.5 %.

(2) Pulse width limited by safe operating area.



# SPN7002L

## N-Channel Enhancement Mode MOSFET

### TYPICAL CHARACTERISTICS

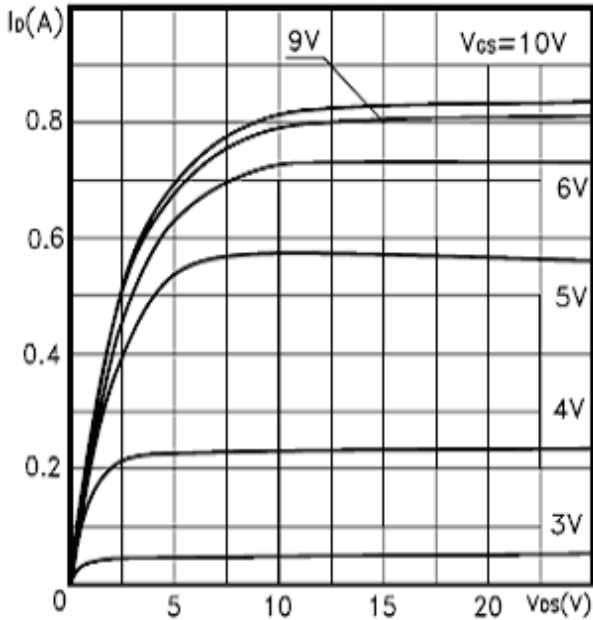

Output Characteristics

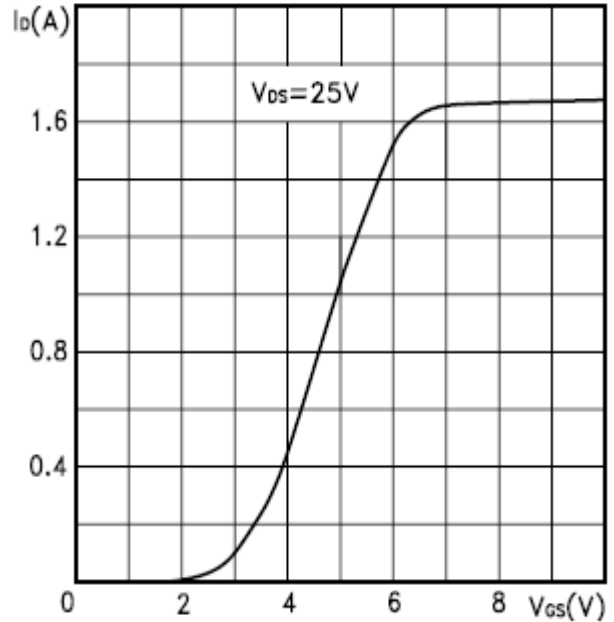

Transfer Characteristics

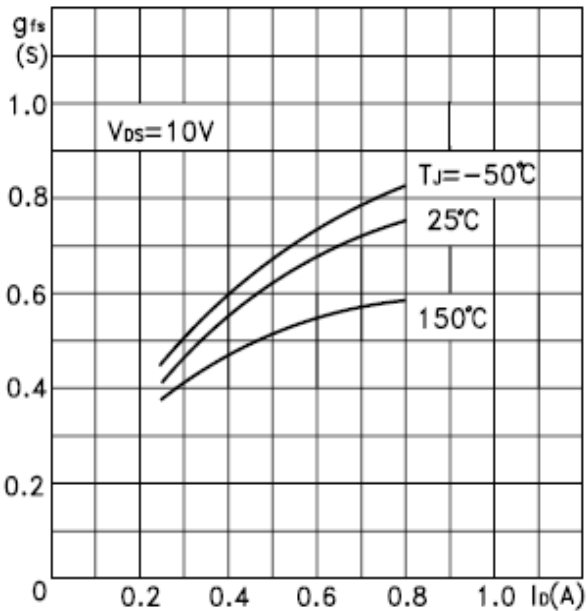

Transconductance

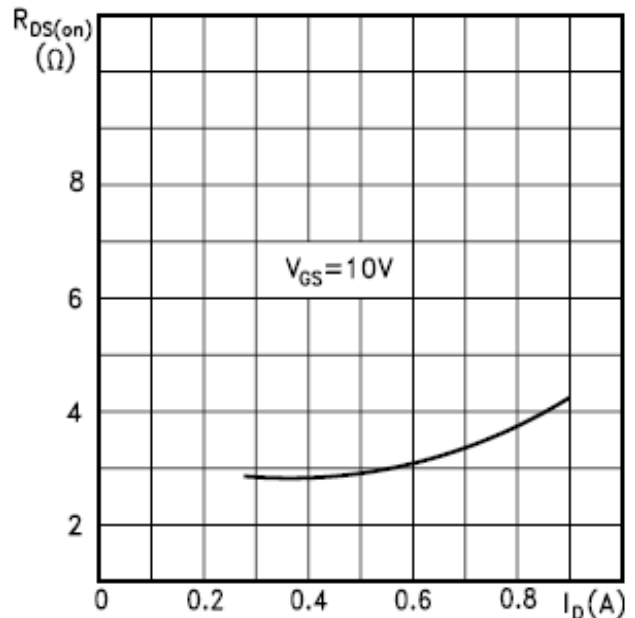

Static Drain-source On Resistance



# SPN7002L

## N-Channel Enhancement Mode MOSFET

### TYPICAL CHARACTERISTICS

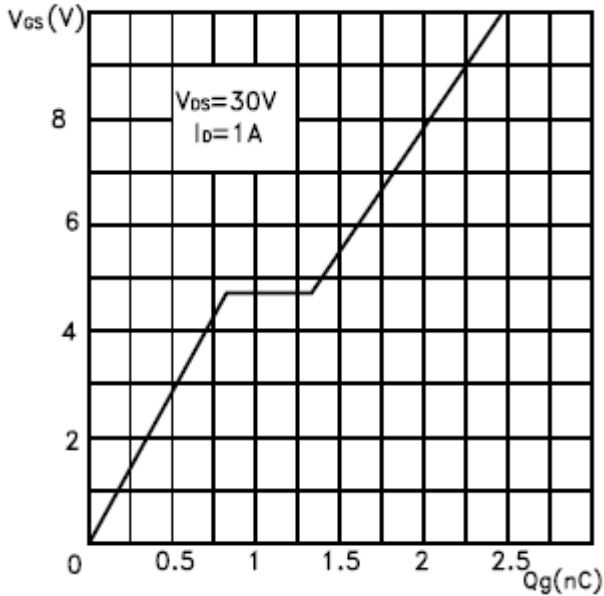

Gate Charge vs Gate-source Voltage

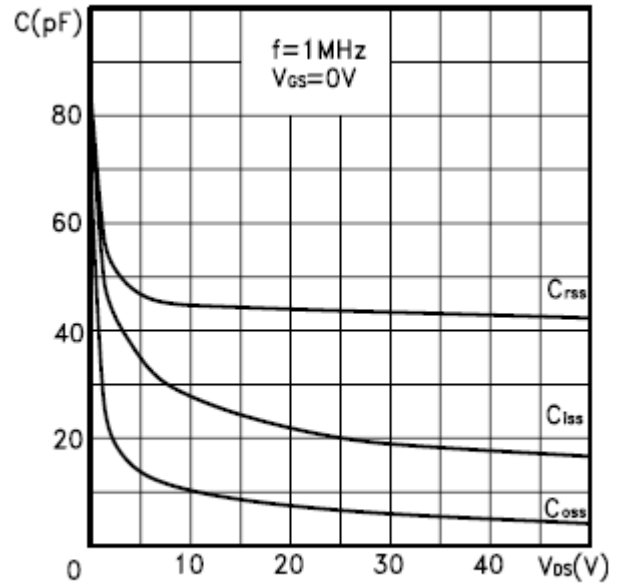

Capacitance Variations

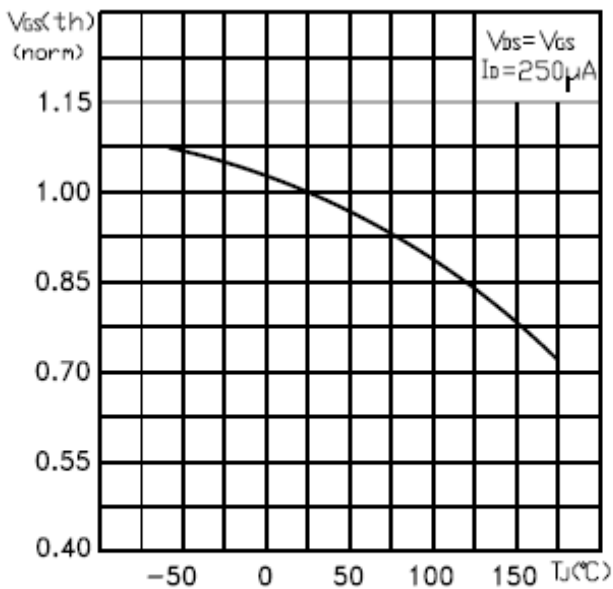

Normalized Gate Threshold Voltage vs Temperature

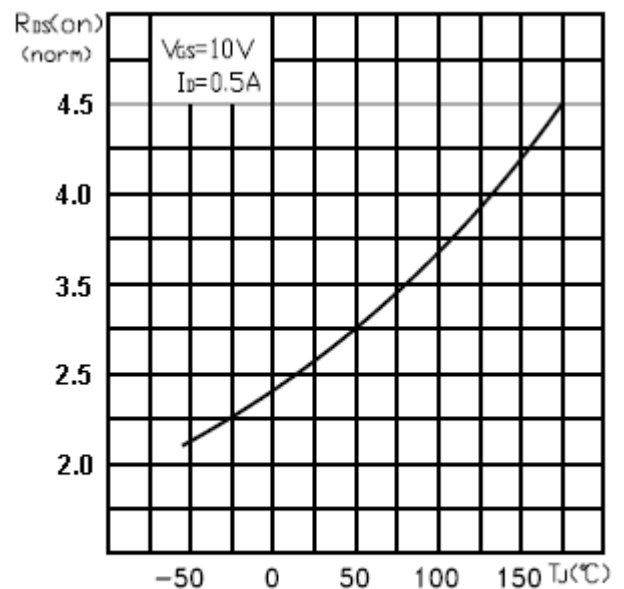

Normalized On Resistance vs Temperature



# SPN7002L N-Channel Enhancement Mode MOSFET

## TYPICAL CHARACTERISTICS

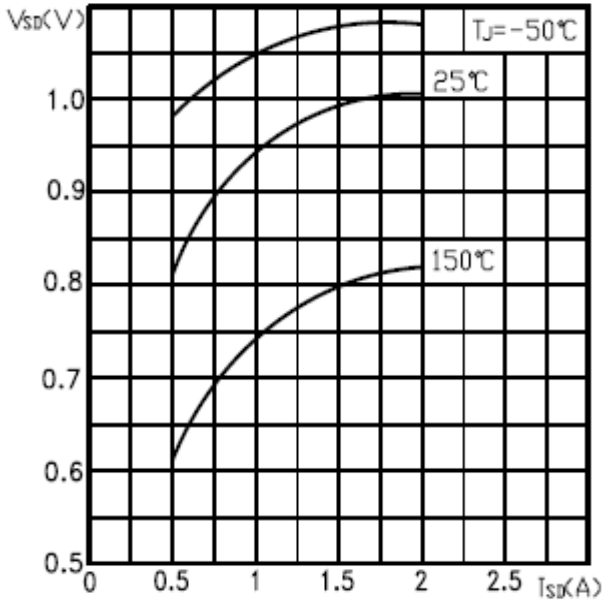

Source-Drain Forward

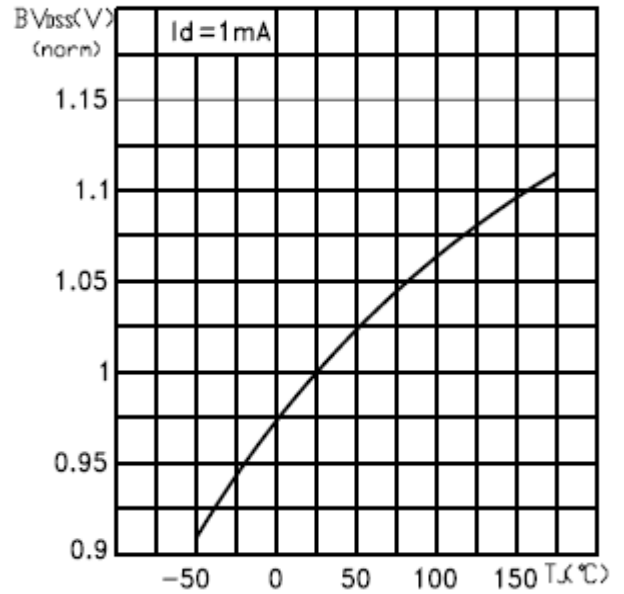

Normalized BVDSS vs Temperature

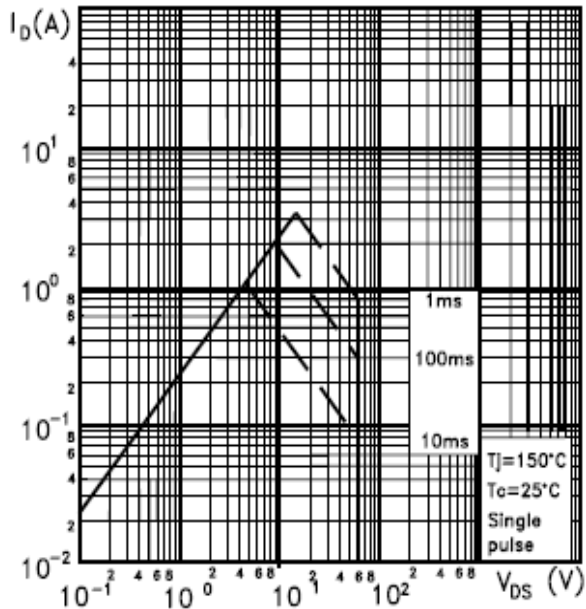

Safe Operating Area

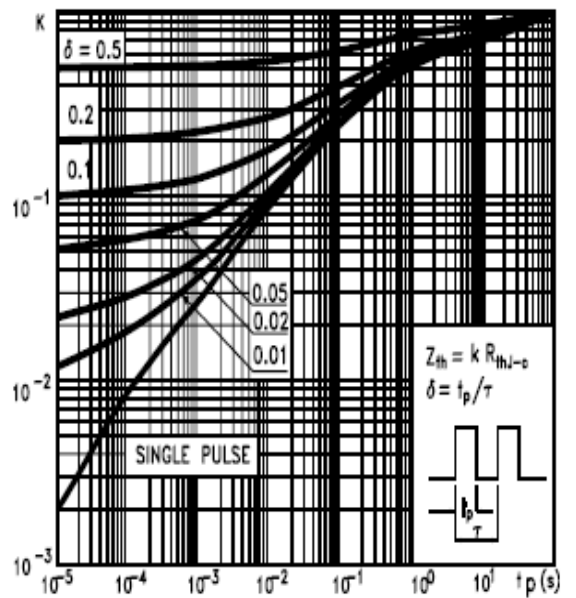

Thermal Impedance



# SPN7002L N-Channel Enhancement Mode MOSFET

## TYPICAL TESTING CIRCUIT

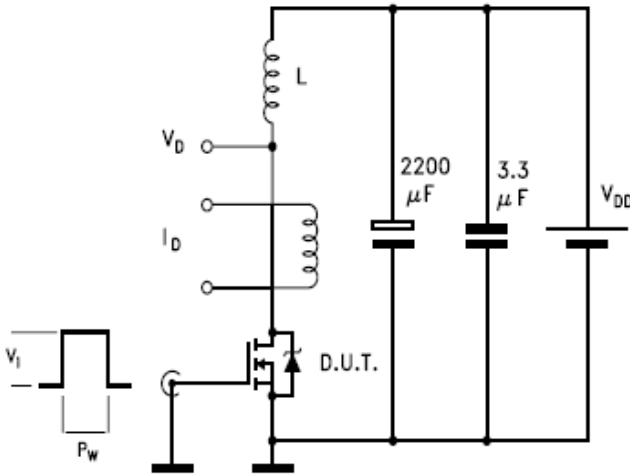

Unclamped Inductive Load Test

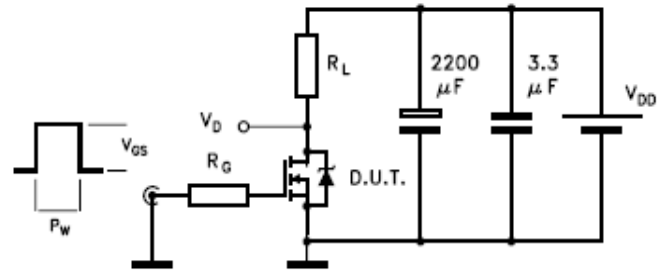

Switching Times Test Circuit

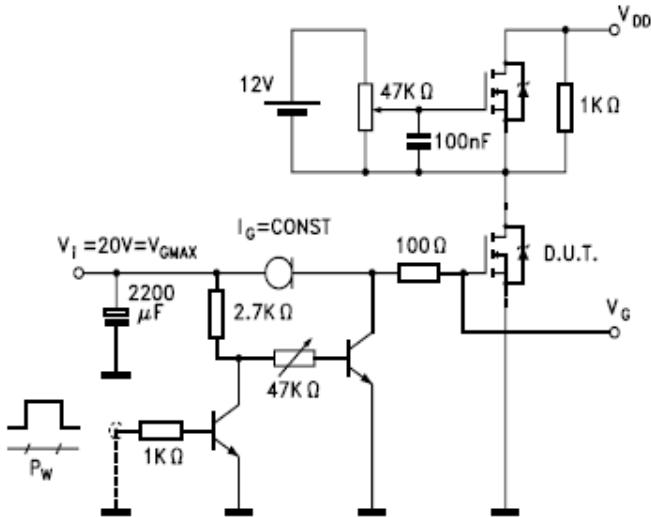

Gate Charge Test Circuit

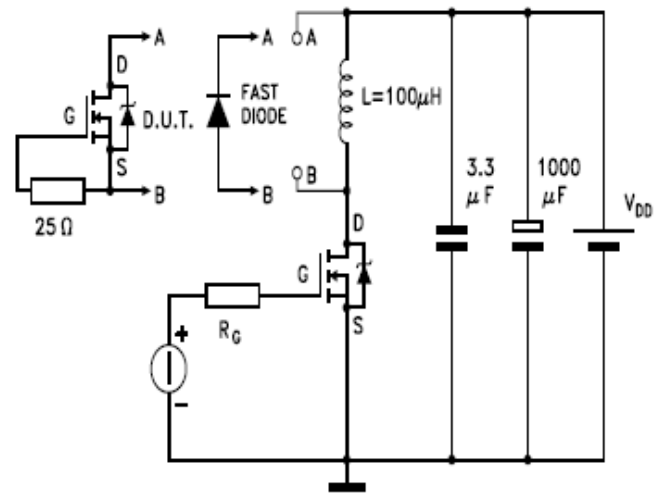

Test Circuit For Inductive Load  
Switching and Diode Recovery Times



# SPN7002L

## N-Channel Enhancement Mode MOSFET

### SOT-23 PACKAGE OUTLINE

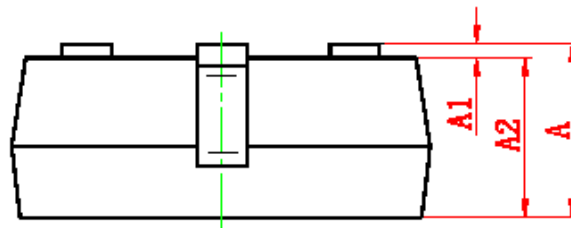
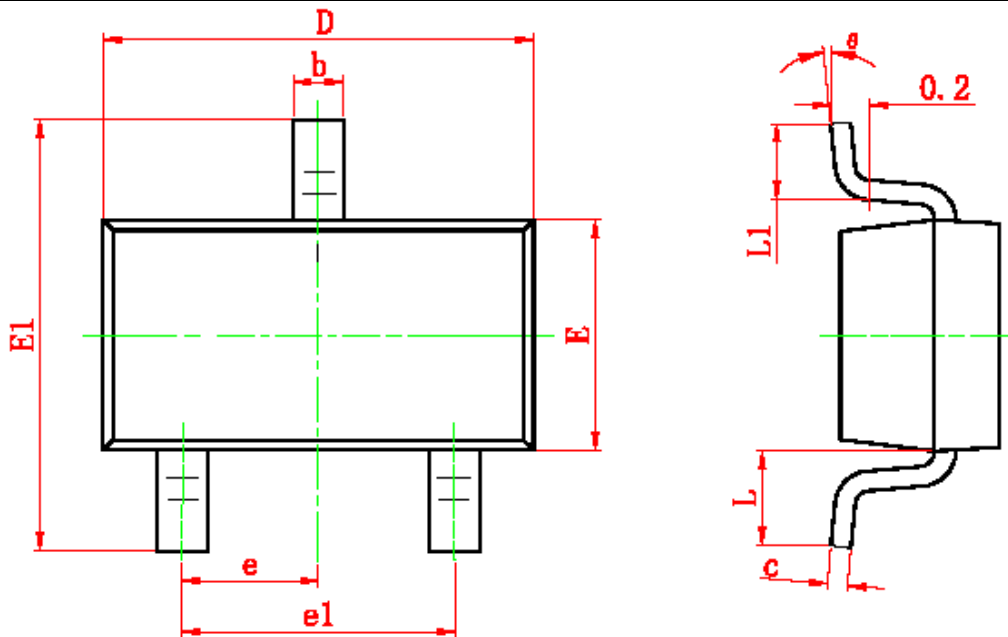

Symbol	Dimensions In Millimeters		Dimensions In Inches	
	Min	Max	Min	Max
A	0.900	1.200	0.035	0.043
A1	0.000	0.100	0.000	0.004
A2	0.900	1.100	0.035	0.039
b	0.300	0.500	0.012	0.020
c	0.080	0.150	0.003	0.006
D	2.800	3.000	0.110	0.118
E	1.200	1.400	0.047	0.055
E1	2.250	2.550	0.089	0.100
e	0.950 TYP		0.037 TYP	
e1	1.800	2.000	0.071	0.079
L	0.550 REF		0.022 REF	
L1	0.300	0.500	0.012	0.020
θ	0°	8°	0°	6°





# SPN7002L

## N-Channel Enhancement Mode MOSFET

---

Information provided is alleged to be exact and consistent. SYNC Power Corporation presumes no responsibility for the penalties of use of such information or for any violation of patents or other rights of third parties which may result from its use. No license is granted by allegation or otherwise under any patent or patent rights of SYNC Power Corporation. Conditions mentioned in this publication are subject to change without notice. This publication surpasses and replaces all information previously supplied. SYNC Power Corporation products are not authorized for use as critical components in life support devices or systems without express written approval of SYNC Power Corporation.

© The SYNC Power logo is a registered trademark of SYNC Power Corporation

© 2016 SYNC Power Corporation – Printed in Taiwan – All Rights Reserved

SYNC Power Corporation

9F-5, No.3-2, Park Street

NanKang District (NKSP), Taipei, Taiwan, 115, R.O.C

Phone: 886-2-2655-8178

Fax: 886-2-2655-8468

© <http://www.syncpower.com>