



SPN75T15 N-Channel Enhancement Mode MOSFET

DESCRIPTION

The SPN75T15 is the N-Channel logic enhancement mode power field effect transistors are produced using high cell density, DMOS trench technology. The SPN75T15 has been designed specifically to improve the overall efficiency of DC/DC converters using either synchronous or conventional switching PWM controllers. It has been optimized for low gate charge, low $R_{DS(ON)}$ and fast switching speed.

FEATURES

- ◆ 150V/75A, $R_{DS(ON)}=12.5\text{ m}\Omega@V_{GS}=10\text{V}$
- ◆ 150V/75A, $R_{DS(ON)}=16\text{ m}\Omega@V_{GS}=4.5\text{V}$
- ◆ Super high density cell design for extremely low $R_{DS(ON)}$
- ◆ Exceptional on-resistance and maximum DC current capability
- ◆ PPAK5x6-8L package design

APPLICATIONS

- DC/DC Converter
- Load Switch
- SMPS Secondary Side Synchronous Rectifier
- Motor Control
- Power Tool

PIN CONFIGURATION(PPAK5x6-8L)

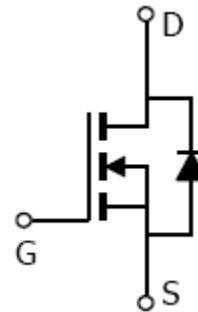
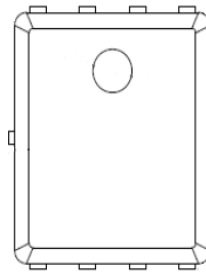

PART MARKING

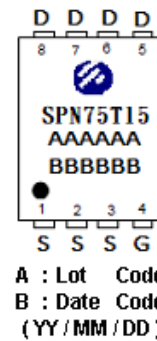



SPN75T15

N-Channel Enhancement Mode MOSFET

PIN DESCRIPTION

Pin	Symbol	Description
1	S	Source
2	S	Source
3	S	Source
4	G	Gate
5	D	Drain
6	D	Drain
7	D	Drain
8	D	Drain

ORDERING INFORMATION

Part Number	Package	Part Marking
SPN75T15DN8RGB	PPAK5x6-8L	SPN75T15

※ SPN75T15DN8RGB : Tape Reel ; Pb – Free ; Halogen - Free

ABSOLUTE MAXIMUM RATINGS

(TA=25°C Unless otherwise noted)

Parameter	Symbol	Typical	Unit	
Drain-Source Voltage	V _{DSS}	150	V	
Gate –Source Voltage	V _{GSS}	±20	V	
Continuous Drain Current (Silicon Limited)	I _D	T _C =25°C	75	A
		T _C =100°C	48	
Pulsed Drain Current	I _{DM}	260	A	
Single Pulse Avalanche Energy (T _C =25°C , L=0.4mH.)	E _{AS}	320	mJ	
Power Dissipation	P _D	83	W	
Operating Junction Temperature	T _J	-55/150	°C	
Storage Temperature Range	T _{STG}	-55/150	°C	
Thermal Resistance-Junction to Case	R _{θJC}	1.5	°C/W	



SPN75T15

N-Channel Enhancement Mode MOSFET

ELECTRICAL CHARACTERISTICS

(TA=25°C Unless otherwise noted)

Parameter	Symbol	Conditions	Min.	Typ	Max.	Unit
Static						
Drain-Source Breakdown Voltage	$V_{(BR)DSS}$	$V_{GS}=0V, I_D=250\mu A$	150			V
Gate Threshold Voltage	$V_{GS(th)}$	$V_{DS}=V_{GS}, I_D=250\mu A$	1.0		3.0	
Gate Leakage Current	I_{GSS}	$V_{DS}=0V, V_{GS}=\pm 20V$			± 100	nA
Zero Gate Voltage Drain Current	I_{DSS}	$V_{DS}=120V, V_{GS}=0V$ $T_J=25^\circ C$,			1	uA
		$V_{DS}=120V, V_{GS}=0V$, $T_J=100^\circ C$			100	
Drain-Source On-Resistance	$R_{DS(on)}$	$V_{GS}=10V, I_D=20A$		9	12.5	mΩ
		$V_{GS}=4.5V, I_D=20A$		10.5	16	
Forward Transconductance	g_{fs}	$V_{DS}=5V, I_D=20A$		85		S
Gate resistance	R_g	$V_{DS}=0V, V_{GS}=0V$ $f=1MHz$		2.6		Ω
Diode Forward Voltage	V_{SD}	$I_S=20A, V_{GS}=0V$		0.9	1.2	V
Dynamic						
Total Gate Charge	$Q_g(10V)$	$V_{DS}=75V, V_{GS}=10V$ $I_D=20A$		48		nC
Total Gate Charge	$Q_g(4.5V)$			21		
Gate-Source Charge	Q_{gs}			13		
Gate-Drain Charge	Q_{gd}			5		
Input Capacitance	C_{iss}	$V_{DS}=75V, V_{GS}=0V$ $f=1MHz$		3794		pF
Output Capacitance	C_{oss}			267		
Reverse Transfer Capacitance	C_{rss}			7.5		
Turn-On Time	$t_{d(on)}$	$V_{DD}=75V$, $I_D=20A, V_{GS}=10V$ $R_G=10\Omega$		18		nS
	t_r			8		
Turn-Off Time	$t_{d(off)}$			29		
	t_f			10		



SPN75T15

N-Channel Enhancement Mode MOSFET

TYPICAL CHARACTERISTICS

Fig 1. Typical Output Characteristics

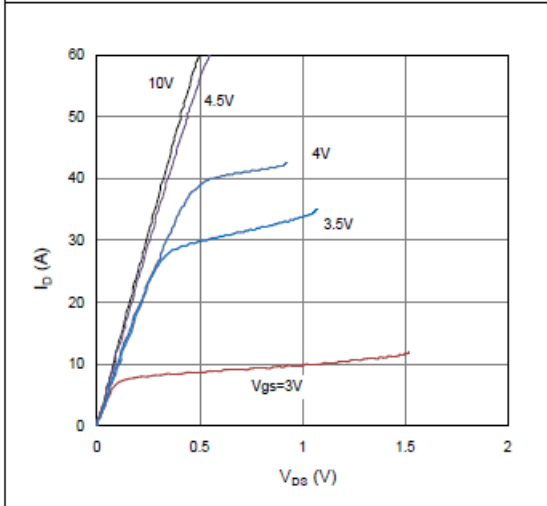

Figure 2. On-Resistance vs. Gate-Source Voltage

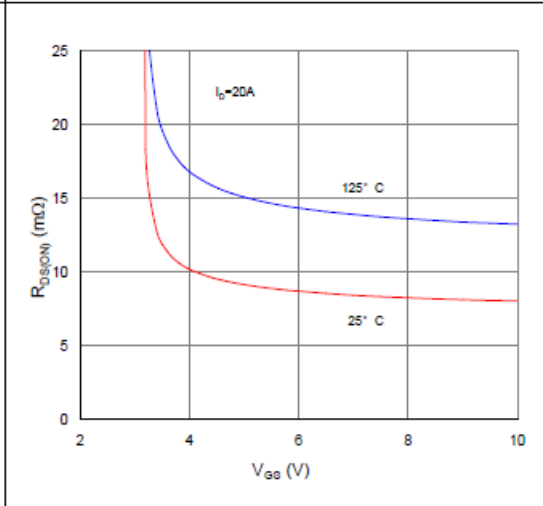

Figure 3. On-Resistance vs. Drain Current and Gate Voltage

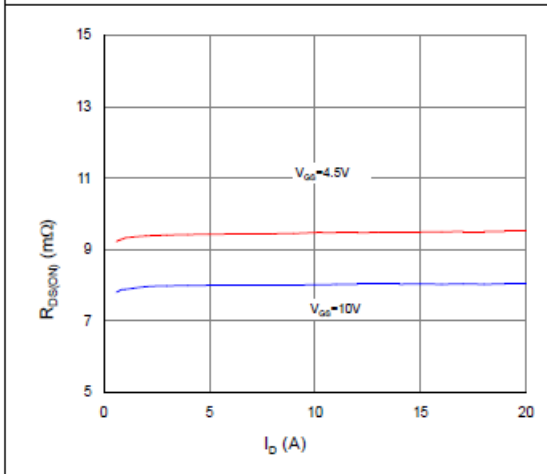

Figure 4. Normalized On-Resistance vs. Junction Temperature

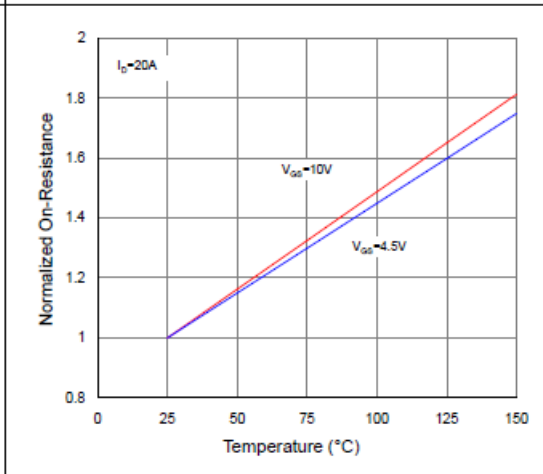

Figure 5. Typical Transfer Characteristics

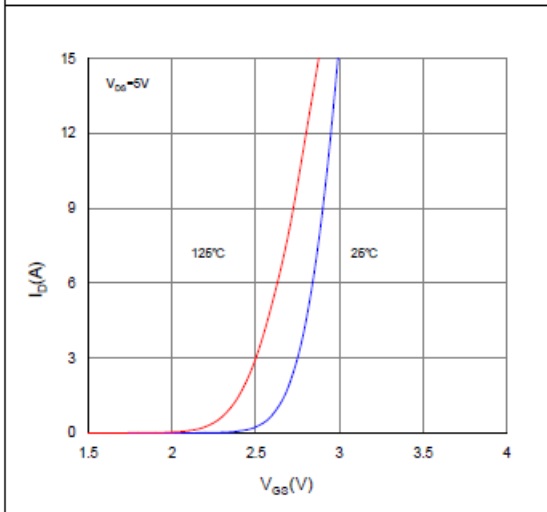
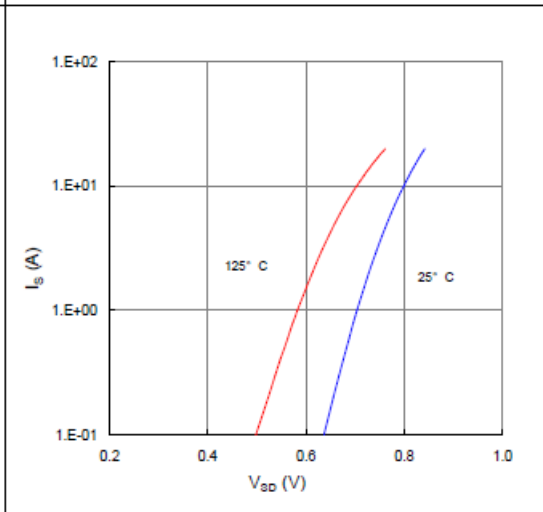

Figure 6. Typical Source-Drain Diode Forward Voltage





SPN75T15 N-Channel Enhancement Mode MOSFET

TYPICAL CHARACTERISTICS

Figure 7. Typical Gate-Charge vs. Gate-to-Source Voltage

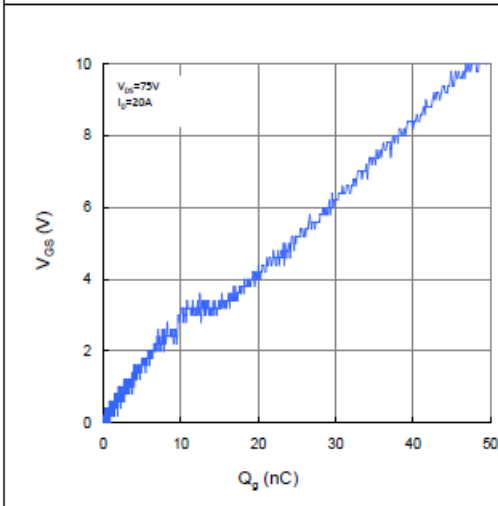

Figure 8. Typical Capacitance vs. Drain-to-Source Voltage

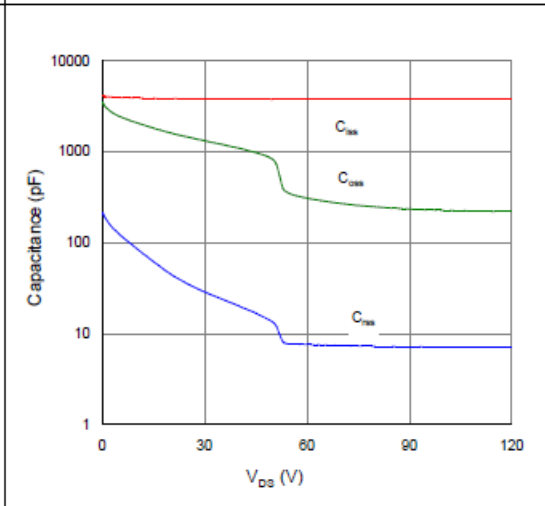

Figure 9. Maximum Safe Operating Area

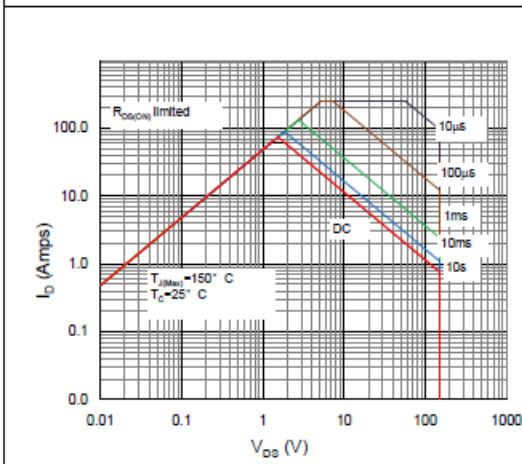

Figure 10. Maximum Drain Current vs. Case Temperature

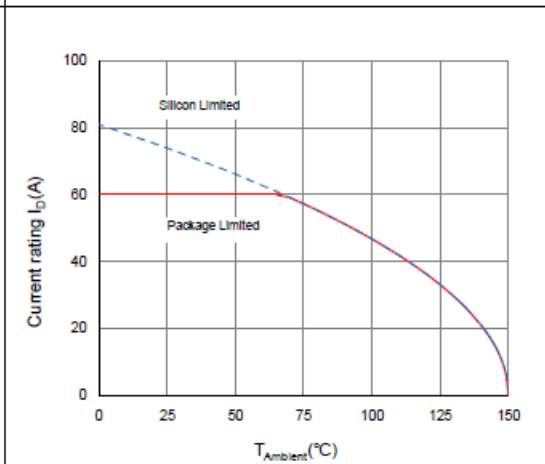
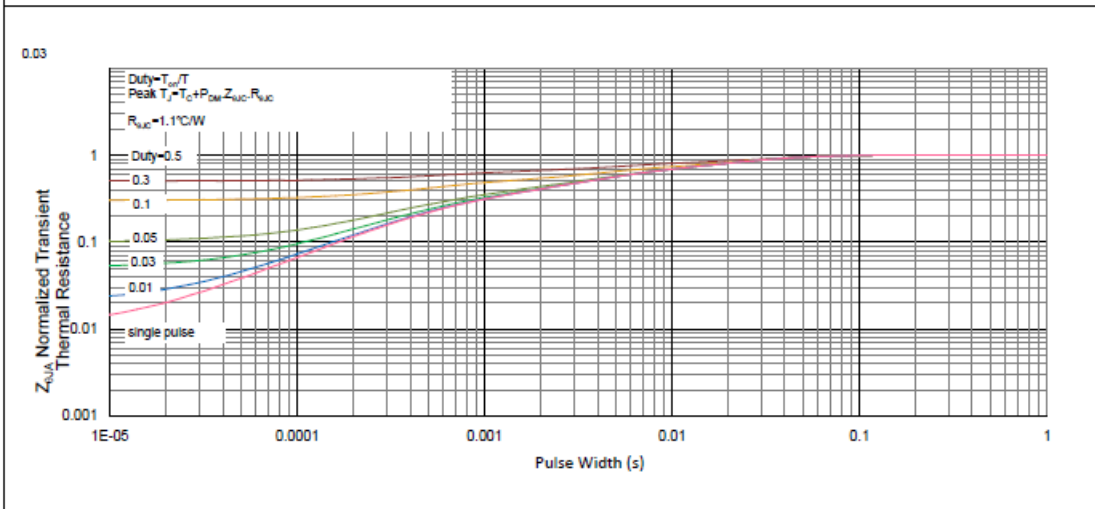

Figure 11. Normalized Maximum Transient Thermal Impedance, Junction-to-Ambient





SPN75T15

N-Channel Enhancement Mode MOSFET

PPAK5x6-8L PACKAGE OUTLINE

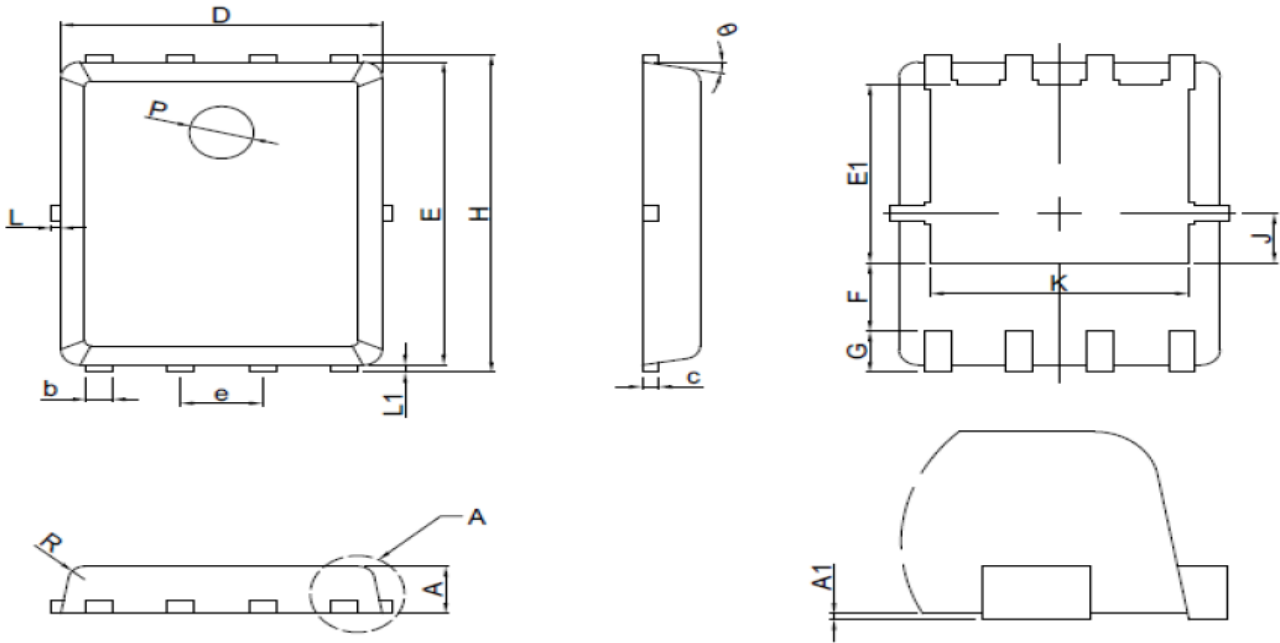

SYMBOL	MILLIMETERS		
	MIN	NOM	MAX
A	0.8	0.95	1.1
A1	0.00	0.03	0.05
b	0.33	0.41	0.51
c	0.254 REF		
D	4.80	4.95	5.10
F	1.40 REF		
E	5.70	5.80	5.90
e	1.27 BSC		
H	5.90	6.05	6.20
L1	0.06	0.13	0.20
G	0.60 REF		
J	0.95 BSC		
K	4.00 REF		
L	---	----	0.20
P	1.00 REF		
E1	3.40REF		
E2	0.95 REF		
θ	6°	10°	14°
R	0.25REF		



SPN75T15

N-Channel Enhancement Mode MOSFET

Information provided is alleged to be exact and consistent. SYNC Power Corporation presumes no responsibility for the penalties of use of such information or for any violation of patents or other rights of third parties which may result from its use. No license is granted by allegation or otherwise under any patent or patent rights of SYNC Power Corporation. Conditions mentioned in this publication are subject to change without notice. This publication surpasses and replaces all information previously supplied. SYNC Power Corporation products are not authorized for use as critical components in life support devices or systems without express written approval of SYNC Power Corporation.

© The SYNC Power logo is a registered trademark of SYNC Power Corporation

© 2019 SYNC Power Corporation – Printed in Taiwan – All Rights Reserved

SYNC Power Corporation

7F-2, No.3-1, Park Street

NanKang District (NKSP), Taipei, Taiwan 115

Phone: 886-2-2655-8178

Fax: 886-2-2655-8468

© <http://www.syncpower.com>