



SPN8838

N-Channel Enhancement Mode MOSFET

DESCRIPTION

The SPN8838 is the N-Channel logic enhancement mode power field effect transistors are produced using high cell density, DMOS trench technology. The SPN8838 has been designed specifically to improve the overall efficiency of DC/DC converters using either synchronous or conventional switching PWM controllers. It has been optimized for low gate charge, low $R_{DS(ON)}$ and fast switching speed.

APPLICATIONS

- High Frequency Synchronous Buck Converter
- DC/DC Power System
- Load Switch

FEATURES

- ◆ 30V/51A, $R_{DS(ON)}=9m\Omega@V_{GS}=10V$
- ◆ 30V/51A, $R_{DS(ON)}=13m\Omega@V_{GS}=4.5V$
- ◆ Super high density cell design for extremely low $R_{DS(ON)}$
- ◆ Exceptional on-resistance and maximum DC current capability
- ◆ PPAK5x6-8L package design

PIN CONFIGURATION(PPAK5x6-8L)

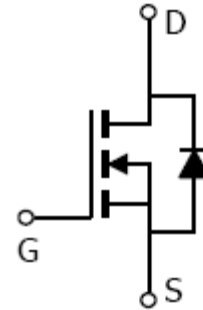
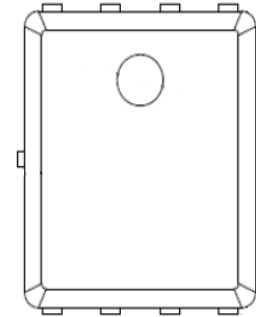

PART MARKING

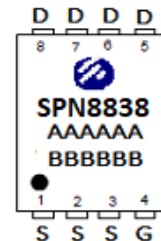

A : Lot Code
 B : Date Code
 (YY / MM / DD)



SPN8838

N-Channel Enhancement Mode MOSFET

PPAK5x6-8L PIN DESCRIPTION

Pin	Symbol	Description
1	S	Source
2	S	Source
3	S	Source
4	G	Gate
5	D	Drain
6	D	Drain
7	D	Drain
8	D	Drain

ORDERING INFORMATION

Part Number	Package	Part Marking
SPN8838DN8RGB	PPAK5x6-8L	SPN8838

※ SPN8838DN8RGB : Tape Reel ; Pb – Free ; Halogen - Free

ABSOLUTE MAXIMUM RATINGS

($T_A=25^{\circ}\text{C}$ Unless otherwise noted)

Parameter	Symbol	Typical	Unit	
Drain-Source Voltage	V_{DSS}	30	V	
Gate –Source Voltage	V_{GSS}	± 20	V	
Continuous Drain Current (Silicon Limited)	I_D	$T_C=25^{\circ}\text{C}$	51	A
		$T_C=100^{\circ}\text{C}$	36	
Pulsed Drain Current	I_{DM}	60	A	
Avalanche Current	I_{AS}	34	A	
Single Pulse Avalanche Energy	EAS	130	mJ	
Power Dissipation	P_D	83	W	
Operating Junction Temperature	T_J	150	$^{\circ}\text{C}$	
Storage Temperature Range	T_{STG}	-55/150	$^{\circ}\text{C}$	
Thermal Resistance-Junction to Case	$R_{\theta JC}$	1.5	$^{\circ}\text{C}/\text{W}$	
Thermal Resistance-Junction to Ambient	$R_{\theta JA}$	55	$^{\circ}\text{C}/\text{W}$	



SPN8838

N-Channel Enhancement Mode MOSFET

ELECTRICAL CHARACTERISTICS

(TA=25°C Unless otherwise noted)

Parameter	Symbol	Conditions	Min.	Typ	Max.	Unit
Static						
Drain-Source Breakdown Voltage	$V_{(BR)DSS}$	$V_{GS}=0V, I_D=250\mu A$	30			V
Gate Threshold Voltage	$V_{GS(th)}$	$V_{DS}=V_{GS}, I_D=250\mu A$	1.0		2.5	V
Gate Leakage Current	I_{GSS}	$V_{DS}=0V, V_{GS}=\pm 20V$			± 100	nA
Zero Gate Voltage Drain Current	I_{DSS}	$V_{DS}=24V, V_{GS}=0V$			1	uA
		$V_{DS}=24V, V_{GS}=0V, T_J=55^\circ C$			5	
On-State Drain Current	$I_{D(on)}$	$V_{DS}\geq 5V, V_{GS}=10V$			51	A
Drain-Source On-Resistance	$R_{DS(on)}$	$V_{GS}=10V, I_D=30A$		7.5	9	mΩ
		$V_{GS}=4.5V, I_D=15A$		11	13	
Forward Transconductance	g_{fs}	$V_{DS}=5V, I_D=30A$		42		S
Diode Forward Voltage	V_{SD}	$I_S=1A, V_{GS}=0V$			1	V
Dynamic						
Total Gate Charge	Q_g	$V_{DS}=15V, V_{GS}=4.5V$ $I_D=15A$		10.6		nC
Gate-Source Charge	Q_{gs}			4.2		
Gate-Drain Charge	Q_{gd}			4		
Input Capacitance	C_{iss}	$V_{DS}=15V, V_{GS}=0V$ $f=1MHz$		1127		pF
Output Capacitance	C_{oss}			194		
Reverse Transfer Capacitance	C_{rss}			78		
Turn-On Time	$t_{d(on)}$	$V_{DD}=15V,$ $I_D=15A, V_{GEN}=10V$ $R_G=3.3\Omega$		6.4	13	nS
	t_r			70	127	
Turn-Off Time	$t_{d(off)}$			22.5	45	
	t_f			8	18	



SPN8838 N-Channel Enhancement Mode MOSFET

TYPICAL CHARACTERISTICS

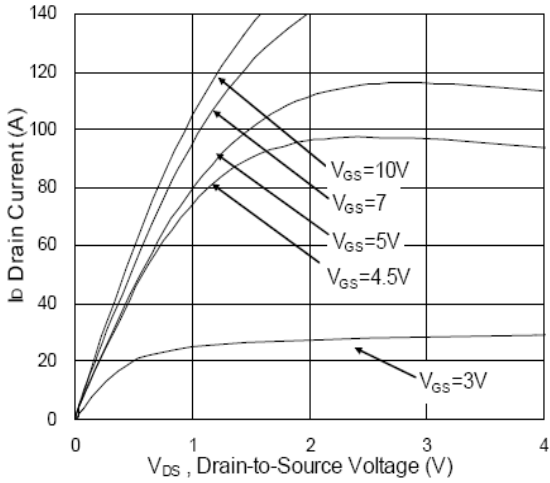

Fig. 1 Typical Output Characteristics

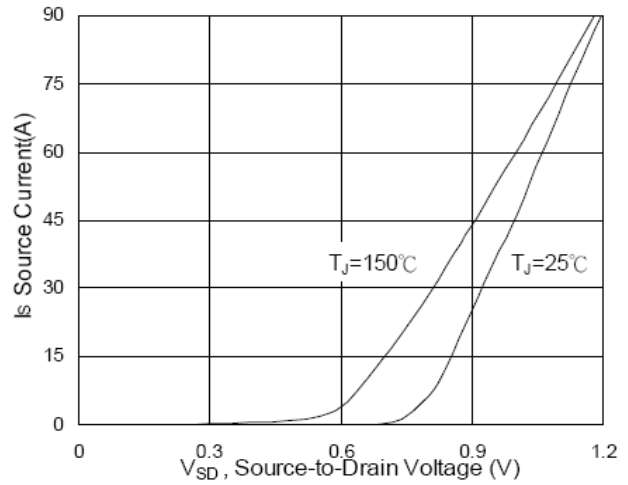

Fig. 2 Transfer Characteristics

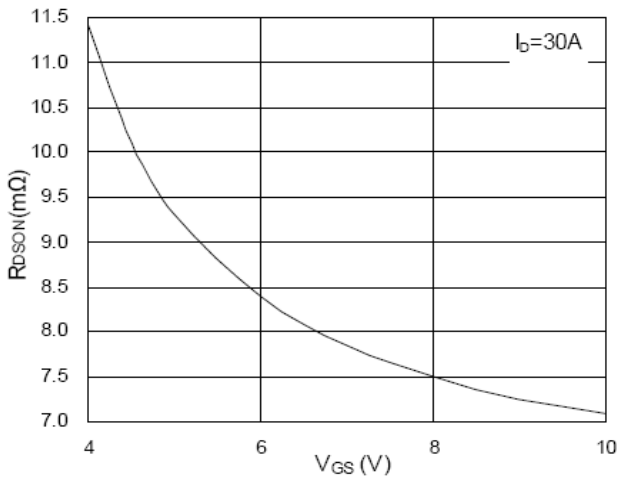

Fig. 3 On-Resistance vs Gate voltage

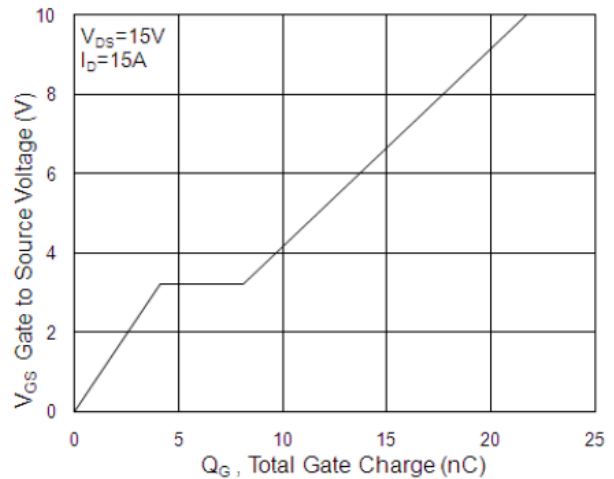

Fig. 4 Gate Charge Characteristics

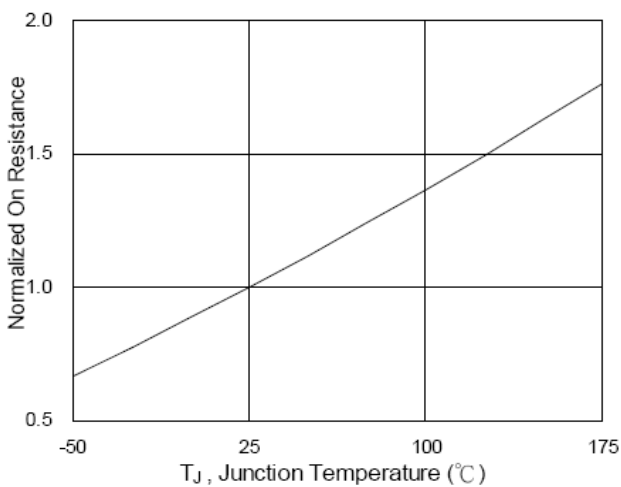

Fig. 5 On-Resistance vs Junction Temp

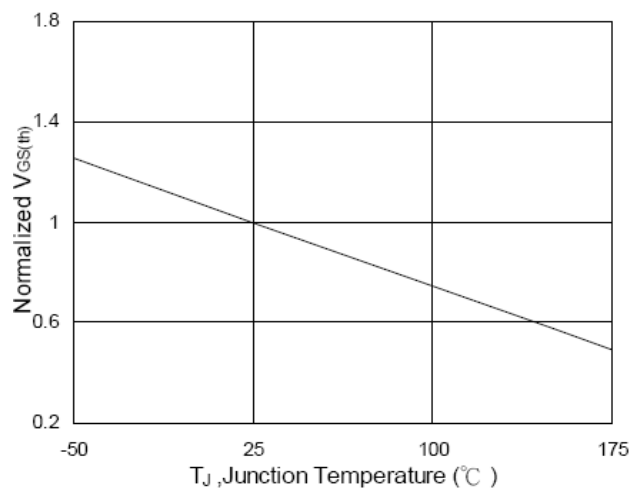

Fig. 6 Vgs vs Junction Temperature



SPN8838 N-Channel Enhancement Mode MOSFET

TYPICAL CHARACTERISTICS

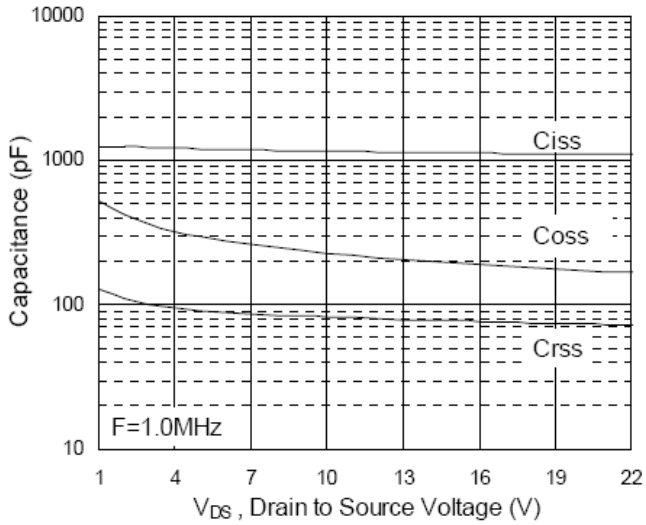

Fig. 7 Typical Capacitance Characteristics

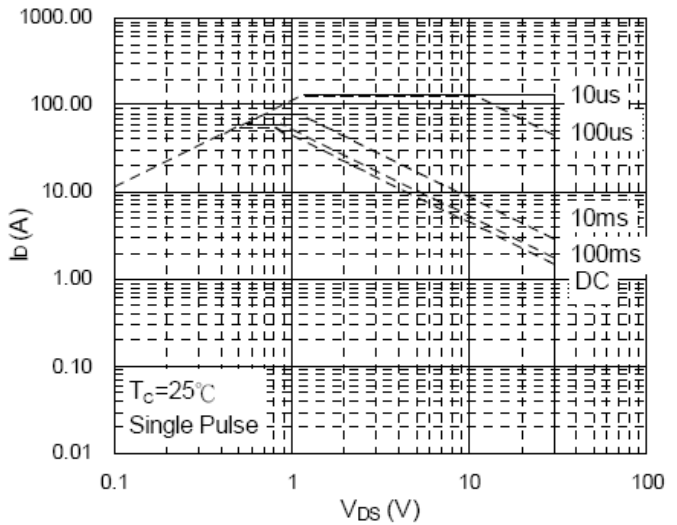

Fig. 8 Maximum Safe Operation Area

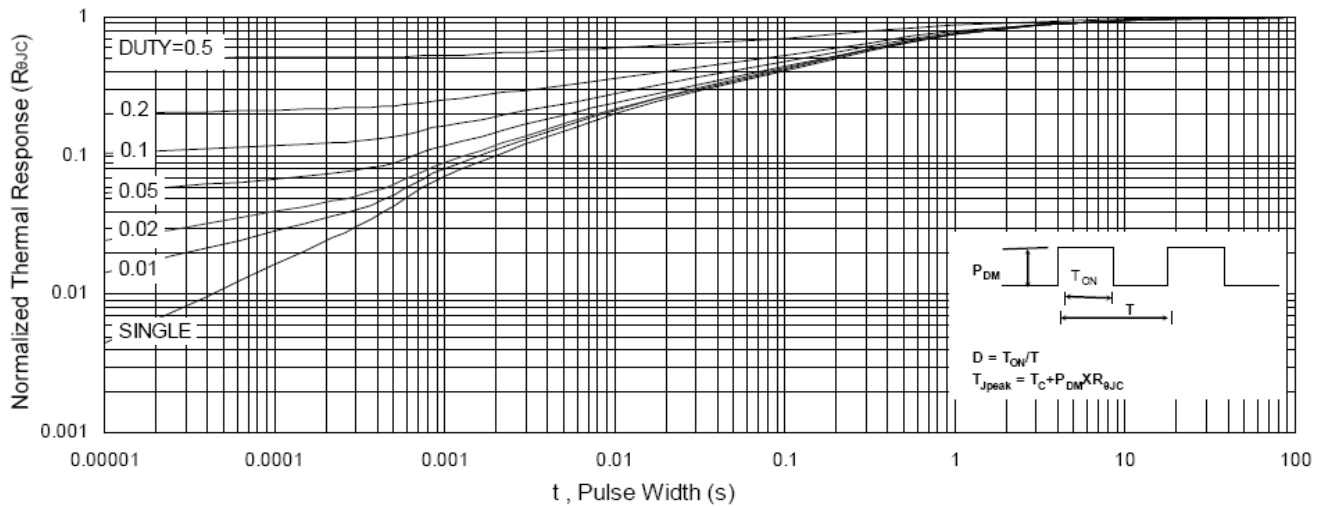

Fig. 9 Effective Transient Thermal Impedance

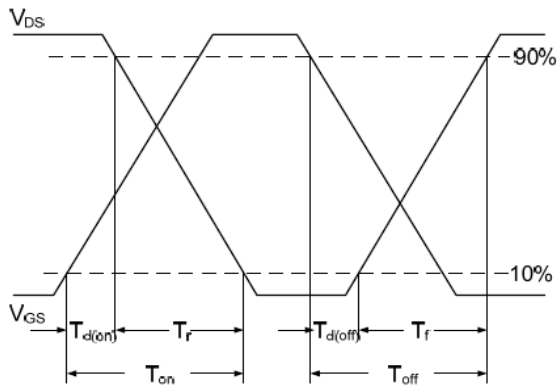

Fig. 10 Switching Time Waveform

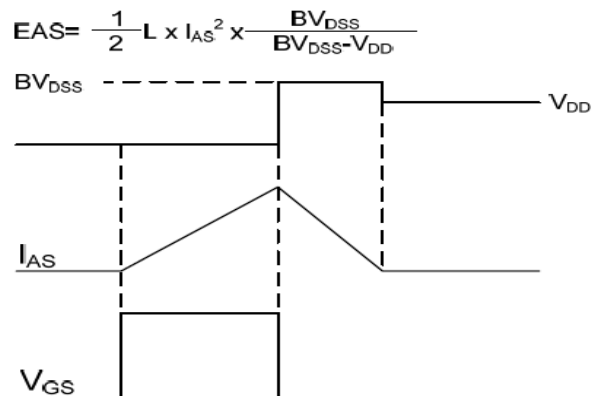

Fig. 11 Unclamped Inductive Waveform



SPN8838

N-Channel Enhancement Mode MOSFET

Information provided is alleged to be exact and consistent. SYNC Power Corporation presumes no responsibility for the penalties of use of such information or for any violation of patents or other rights of third parties which may result from its use. No license is granted by allegation or otherwise under any patent or patent rights of SYNC Power Corporation. Conditions mentioned in this publication are subject to change without notice. This publication surpasses and replaces all information previously supplied. SYNC Power Corporation products are not authorized for use as critical components in life support devices or systems without express written approval of SYNC Power Corporation.

© The SYNC Power logo is a registered trademark of SYNC Power Corporation

© 2021 SYNC Power Corporation – Printed in Taiwan – All Rights Reserved

SYNC Power Corporation

7F-2, No.3-1, Park Street

NanKang District (NKSP), Taipei, Taiwan 115

Phone: 886-2-2655-8178

Fax: 886-2-2655-8468

© <http://www.syncpower.com>