



SPN9926B

N-Channel Enhancement Mode MOSFET

DESCRIPTION

The SPN9926B is the Dual N-Channel logic enhancement mode power field effect transistors are produced using high cell density , DMOS trench technology.

This high density process is especially tailored to minimize on-state resistance.

These devices are particularly suited for low voltage application , notebook computer power management and other battery powered circuits where high-side switching .

FEATURES

- ◆ 20V/6.0A, $R_{DS(ON)}=33m\Omega@V_{GS}=4.5V$
- ◆ 20V/5.0A, $R_{DS(ON)}=38m\Omega@V_{GS}=2.5V$
- ◆ Super high density cell design for extremely low $R_{DS(ON)}$
- ◆ Exceptional on-resistance and maximum DC current capability
- ◆ SOP-8 package design

APPLICATIONS

- Power Management in Note book
- Portable Equipment
- Battery Powered System
- DC/DC Converter
- Load Switch
- DSC
- LCD Display inverter

PIN CONFIGURATION(SOP-8)

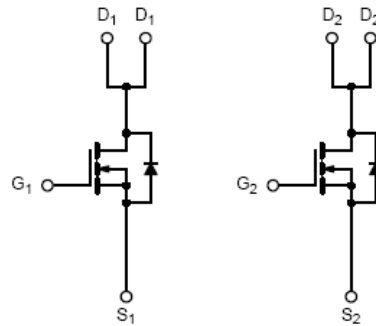
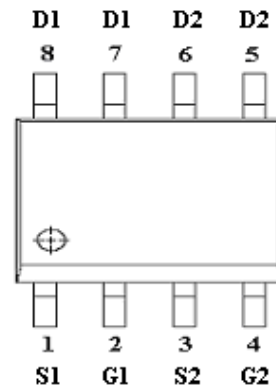

PART MARKING

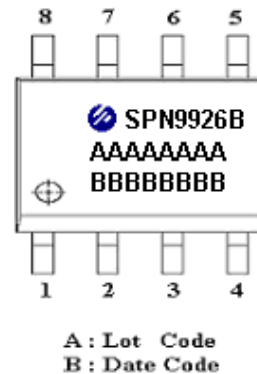



SPN9926B

N-Channel Enhancement Mode MOSFET

PIN DESCRIPTION

| Pin | Symbol | Description |
|-----|--------|-------------|
| 1 | S1 | Source 1 |
| 2 | G1 | Gate 1 |
| 3 | S2 | Source 2 |
| 4 | G2 | Gate 2 |
| 5 | D2 | Drain 2 |
| 6 | D2 | Drain 2 |
| 7 | D1 | Drain 1 |
| 8 | D1 | Drain 1 |

ORDERING INFORMATION

| Part Number | Package | Part Marking |
|---------------|---------|--------------|
| SPN9926BS8RGB | SOP-8 | SPN9926B |

※ SPN9926BS8RGB : 13" Tape Reel ; Pb – Free ; Halogen – Free

ABSOLUTE MAXIMUM RATINGS

(TA=25°C Unless otherwise noted)

| Parameter | Symbol | Typical | Unit | |
|---|------------------|---------|------|---|
| Drain-Source Voltage | V _{DSS} | 20 | V | |
| Gate –Source Voltage | V _{GSS} | ±12 | V | |
| Continuous Drain Current(T _J =150°C) | I _D | TA=25°C | 6.8 | A |
| | | TA=70°C | 4.8 | |
| Pulsed Drain Current | I _{DM} | 30 | A | |
| Continuous Source Current(Diode Conduction) | I _S | 1.6 | A | |
| Power Dissipation | P _D | TA=25°C | 2.8 | W |
| | | TA=70°C | 1.8 | |
| Operating Junction Temperature | T _J | -55/150 | °C | |
| Storage Temperature Range | T _{STG} | -55/150 | °C | |
| Thermal Resistance-Junction to Ambient | R _{θJA} | 105 | °C/W | |



SPN9926B

N-Channel Enhancement Mode MOSFET

ELECTRICAL CHARACTERISTICS

(TA=25°C Unless otherwise noted)

| Parameter | Symbol | Conditions | Min. | Typ | Max. | Unit |
|---------------------------------|---------------|--|------|-------|-----------|----------|
| Static | | | | | | |
| Drain-Source Breakdown Voltage | $V_{(BR)DSS}$ | $V_{GS}=0V, I_D=250\mu A$ | 20 | | | V |
| Gate Threshold Voltage | $V_{GS(th)}$ | $V_{DS}=V_{GS}, I_D=250\mu A$ | 0.5 | | 1.0 | V |
| Gate Leakage Current | I_{GSS} | $V_{DS}=0V, V_{GS}=\pm 12V$ | | | ± 100 | nA |
| Zero Gate Voltage Drain Current | I_{DSS} | $V_{DS}=20V, V_{GS}=0V$ | | | 1 | uA |
| | | $V_{DS}=20V, V_{GS}=0V$ $T_J=55^\circ C$ | | | 5 | |
| On-State Drain Current | $I_{D(on)}$ | $V_{DS} \leq 5V, V_{GS}=4.5V$ | 6 | | | A |
| Drain-Source On-Resistance | $R_{DS(on)}$ | $V_{GS}=4.5V, I_D=6.0A$ | | 0.028 | 0.033 | Ω |
| | | $V_{GS}=2.5V, I_D=5.0A$ | | 0.032 | 0.038 | |
| Forward Transconductance | g_{fs} | $V_{DS}=5V, I_D=-3.6A$ | | 10 | | S |
| Diode Forward Voltage | V_{SD} | $I_S=1.7A, V_{GS}=0V$ | | 0.8 | 1.2 | V |
| Dynamic | | | | | | |
| Total Gate Charge | Q_g | $V_{DS}=10V, V_{GS}=4.5V,$ $I_D=6.0A$ | | 2 | | nC |
| Gate-Source Charge | Q_{gs} | | | 2.5 | | |
| Gate-Drain Charge | Q_{gd} | | | 2.1 | | |
| Input Capacitance | C_{iss} | $V_{DS}=8V, V_{GS}=0V$ $f=1MHz$ | | 575 | | pF |
| Output Capacitance | C_{oss} | | | 84 | | |
| Reverse Transfer Capacitance | C_{rss} | | | 22 | | |
| Turn-On Time | $t_{d(on)}$ | $V_{DD}=10V, R_L=6\Omega$ $I_D=1.0A, V_{GEN}=4.5V$ $R_G=6\Omega$ | | 10 | 14 | nS |
| | t_r | | | 16 | 20 | |
| Turn-Off Time | $t_{d(off)}$ | | | 35 | 40 | |
| | t_f | | | 3 | 10 | |



SPN9926B

N-Channel Enhancement Mode MOSFET

TYPICAL CHARACTERISTICS

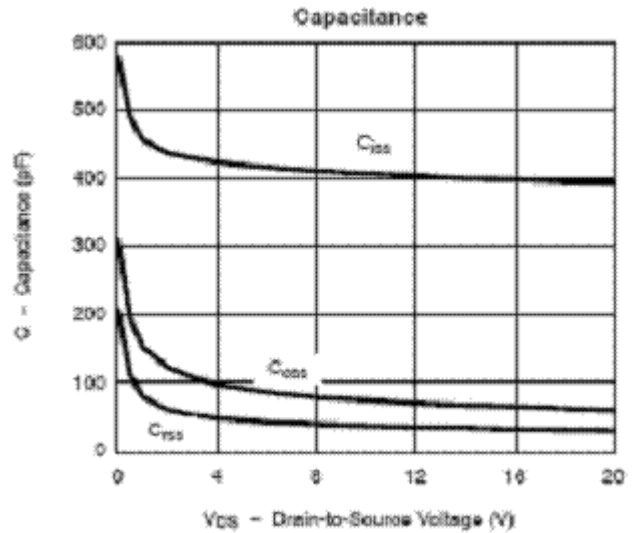
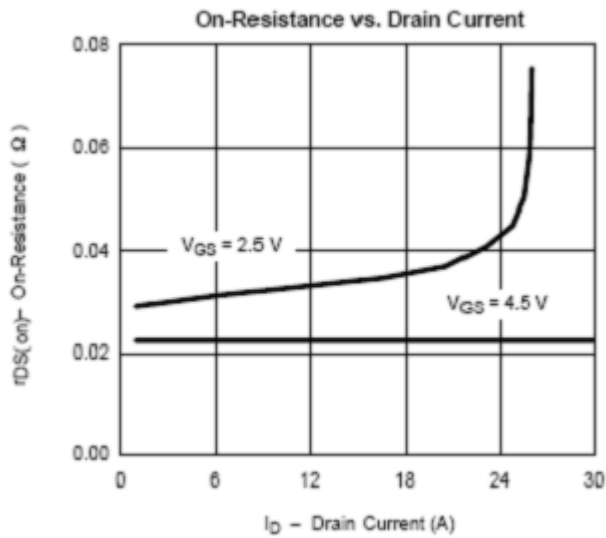
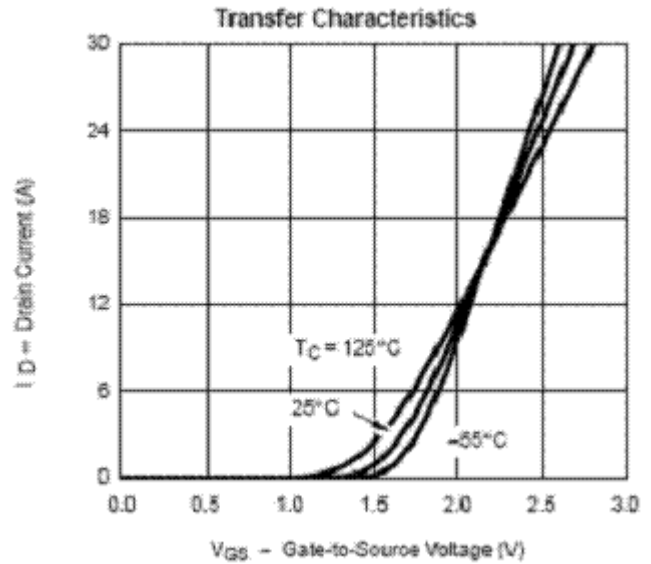
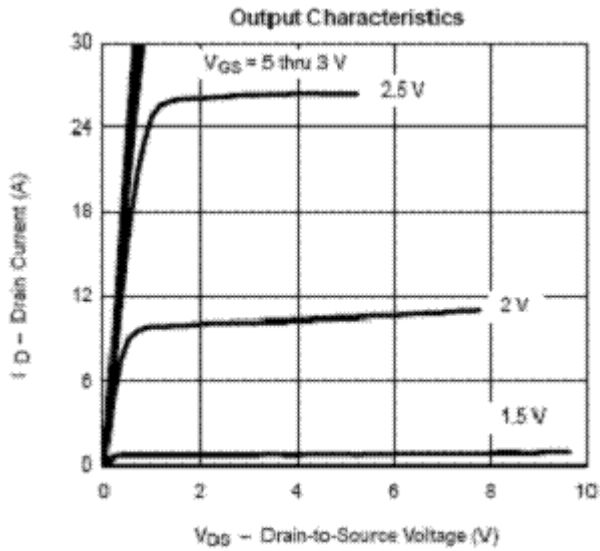



SPN9926B

N-Channel Enhancement Mode MOSFET

TYPICAL CHARACTERISTICS

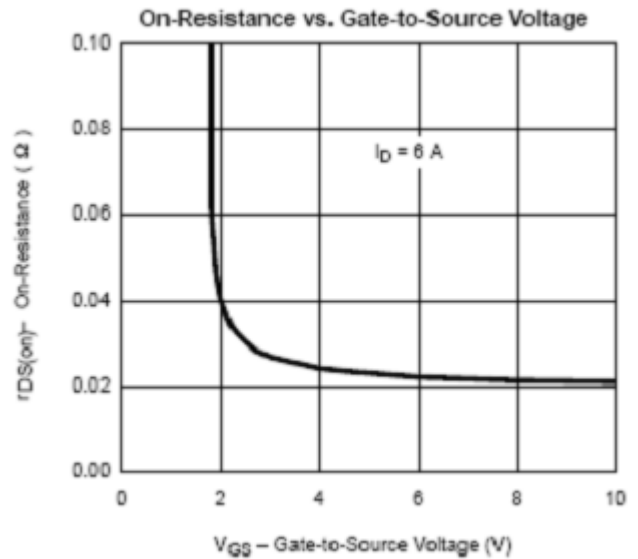
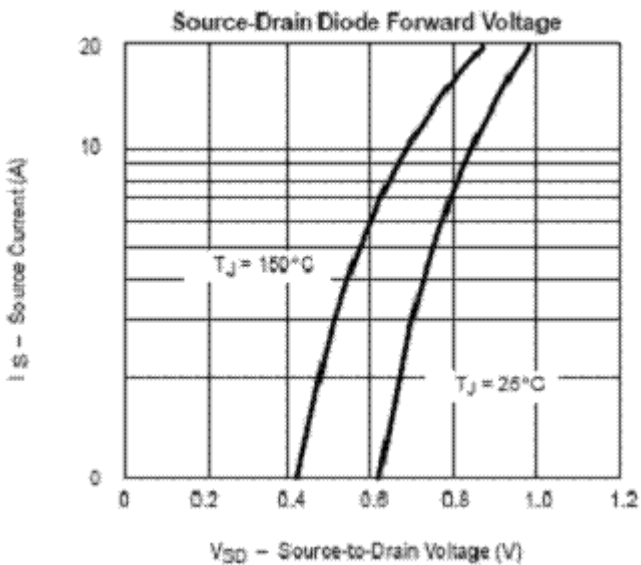
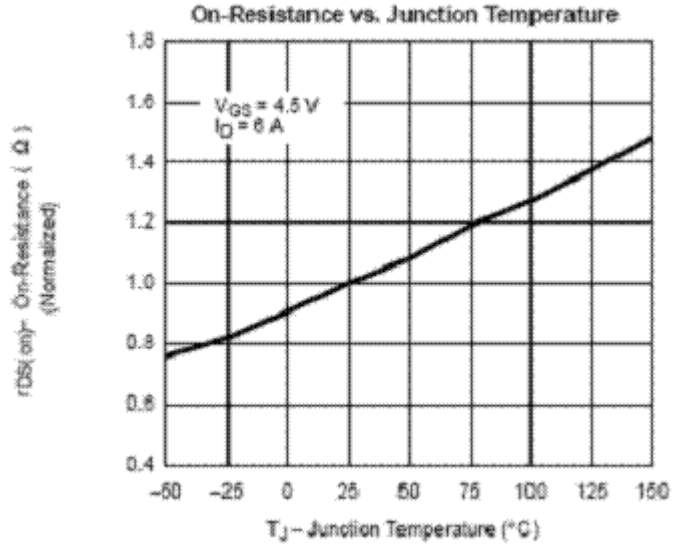
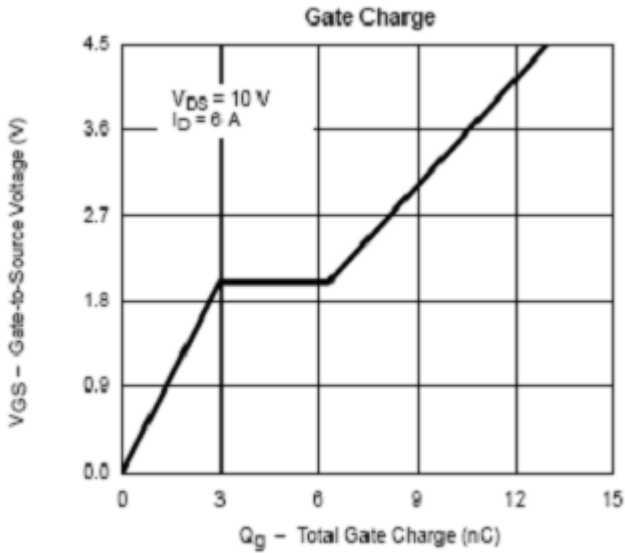



SPN9926B

N-Channel Enhancement Mode MOSFET

TYPICAL CHARACTERISTICS

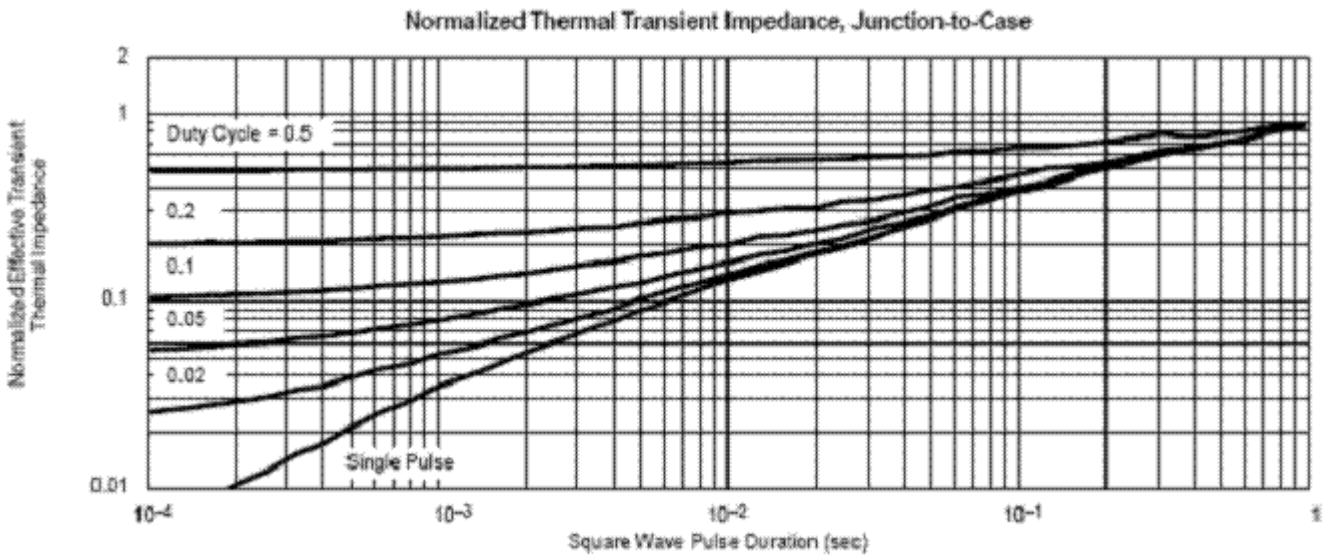
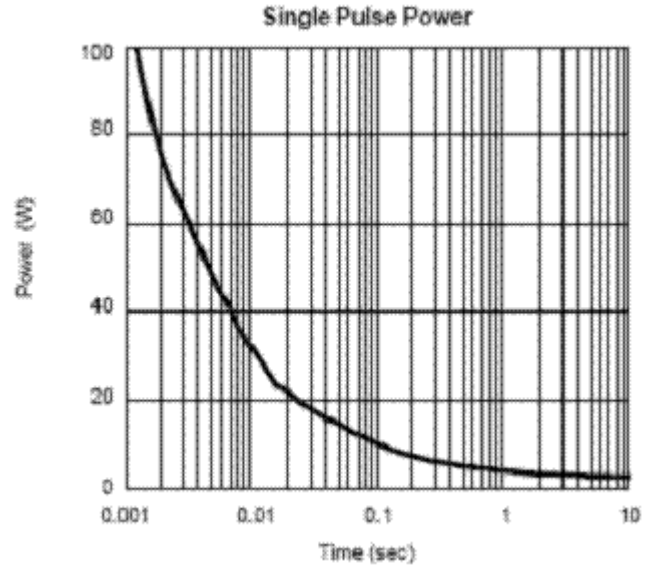
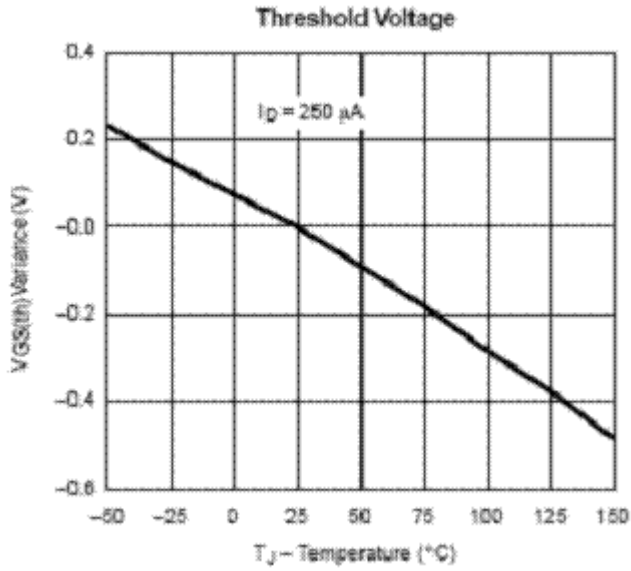



SPN9926B

N-Channel Enhancement Mode MOSFET

Information provided is alleged to be exact and consistent. SYNC Power Corporation presumes no responsibility for the penalties of use of such information or for any violation of patents or other rights of third parties which may result from its use. No license is granted by allegation or otherwise under any patent or patent rights of SYNC Power Corporation. Conditions mentioned in this publication are subject to change without notice. This publication surpasses and replaces all information previously supplied. SYNC Power Corporation products are not authorized for use as critical components in life support devices or systems without express written approval of SYNC Power Corporation.

© The SYNC Power logo is a registered trademark of SYNC Power Corporation

© 2020 SYNC Power Corporation – Printed in Taiwan – All Rights Reserved

SYNC Power Corporation

7F-2, No.3-1, Park Street

NanKang District (NKSP), Taipei, Taiwan 115

Phone: 886-2-2655-8178

Fax: 886-2-2655-8468

© <http://www.syncpower.com>