



# SPP1071

## P-Channel Enhancement Mode MOSFET

### DESCRIPTION

The SPP1071 is the P-Channel enhancement mode power field effect transistors are produced using high cell density , DMOS trench technology. This high density process is especially tailored to minimize on-state resistance and provide superior switching performance. These devices are particularly suited for low voltage applications such as notebook computer power management and other battery powered circuits where high-side switching , low in-line power loss, and resistance to transients are needed.

### FEATURES

- ◆ P-Channel  
 -20V/0.45A, $R_{DS(ON)}=0.52\Omega@V_{GS}=-4.5V$   
 -20V/0.35A, $R_{DS(ON)}=0.70\Omega@V_{GS}=-2.5V$   
 -20V/0.25A, $R_{DS(ON)}=1.5\Omega@V_{GS}=-1.8V$
- ◆ Super high density cell design for extremely low  $R_{DS(ON)}$
- ◆ Exceptional on-resistance and maximum DC current capability
- ◆ SOT-723 package design

### APPLICATIONS

- Drivers : Relays/Solenoids/Lamps/Hammers
- Power Supply Converter Circuits
- Load/Power Switching Cell Phones, Pagers

### PIN CONFIGURATION( SOT-723 )

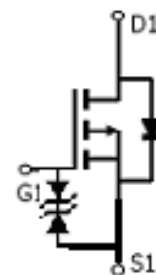
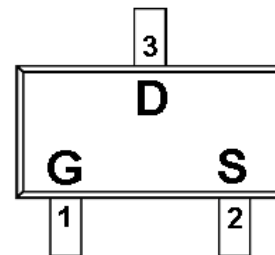

### PART MARKING

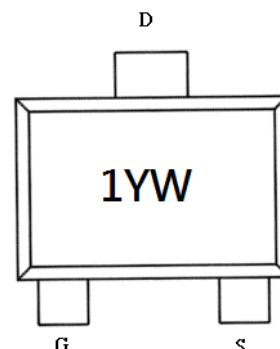



# SPP1071

## P-Channel Enhancement Mode MOSFET

### PIN DESCRIPTION

Pin	Symbol	Description
1	G	Gate
2	S	Source
3	D	Drain

### ORDERING INFORMATION

Part Number	Package	Part Marking
SPP1071S72RGB	SOT-723	1

※ SPP1071S72RGB : Tape Reel ; Pb – Free, Halogen – Free

### ABSOLUTE MAXIMUM RATINGS

(TA=25°C Unless otherwise noted)

Parameter	Symbol	Typical	Unit
Drain-Source Voltage	V <sub>DSS</sub>	-20	V
Gate –Source Voltage	V <sub>GSS</sub>	±12	V
Continuous Drain Current(T <sub>J</sub> =150°C)	I <sub>D</sub>	-0.45	A
	TA=25°C		
Pulsed Drain Current	I <sub>DM</sub>	-1.0	A
Continuous Source Current(Diode Conduction)	I <sub>S</sub>	-0.3	A
Power Dissipation	P <sub>D</sub>	0.15	W
	TA=25°C		
Operating Junction Temperature	T <sub>J</sub>	-55/150	°C
Storage Temperature Range	T <sub>STG</sub>	-55/150	°C



# SPP1071

## P-Channel Enhancement Mode MOSFET

### ELECTRICAL CHARACTERISTICS

(TA=25°C Unless otherwise noted)

Parameter	Symbol	Conditions	Min.	Typ	Max.	Unit
<b>Static</b>						
Drain-Source Breakdown Voltage	$V_{(BR)DSS}$	$V_{GS}=0V, I_D=-250\mu A$	-20			V
Gate Threshold Voltage	$V_{GS(th)}$	$V_{DS}=V_{GS}, I_D=-250\mu A$	-0.35		-1.0	
Gate Leakage Current	$I_{GSS}$	$V_{DS}=0V, V_{GS}=\pm 12V$			$\pm 30$	$\mu A$
Zero Gate Voltage Drain Current	$I_{DSS}$	$V_{DS}=-20V, V_{GS}=0V$			-1	$\mu A$
		$V_{DS}=-20V, V_{GS}=0V$ $T_J=55^\circ C$			-5	
On-State Drain Current	$I_{D(on)}$	$V_{DS}\leq -4.5V, V_{GS}=-5V$	-0.7			A
Drain-Source On-Resistance	$R_{DS(on)}$	$V_{GS}=-4.5V, I_D=-0.45A$		0.42	0.52	$\Omega$
		$V_{GS}=-2.5V, I_D=-0.35A$		0.58	0.70	
		$V_{GS}=-1.8V, I_D=-0.25A$		0.95	1.5	
Forward Transconductance	$g_{fs}$	$V_{DS}=-10V, I_D=-0.25A$		0.4		S
Diode Forward Voltage	$V_{SD}$	$I_S=-0.15A, V_{GS}=0V$		-0.8	-1.2	V
<b>Dynamic</b>						
Total Gate Charge	$Q_g$	$V_{DS}=-10V, V_{GS}=-4.5V, I_D=-0.6A$		1.5	2.0	nC
Gate-Source Charge	$Q_{gs}$			0.3		
Gate-Drain Charge	$Q_{gd}$			0.35		
Turn-On Time	$t_{d(on)}$	$V_{DD}=-10V, R_L=10\Omega, I_D=-0.4A$ $V_{GEN}=-4.5V, R_G=6\Omega$		5	10	ns
	$t_r$			15	25	
Turn-Off Time	$t_{d(off)}$			8	15	
	$t_f$			1.4	1.8	



# SPP1071

## P-Channel Enhancement Mode MOSFET

### TYPICAL CHARACTERISTICS

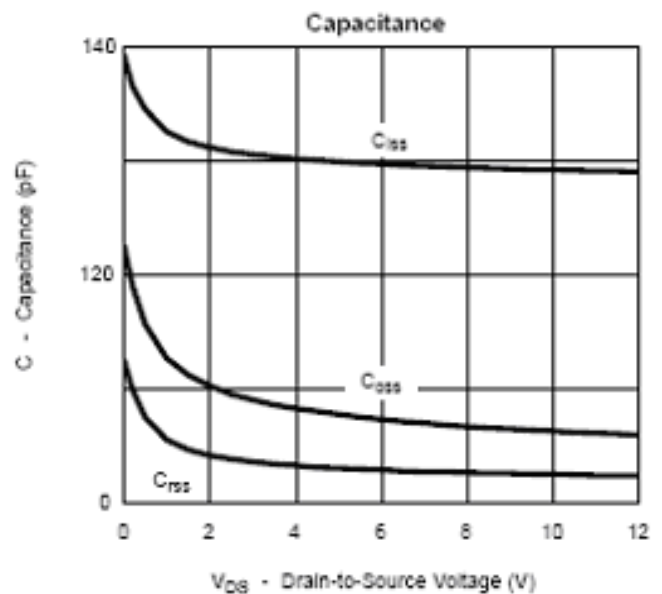
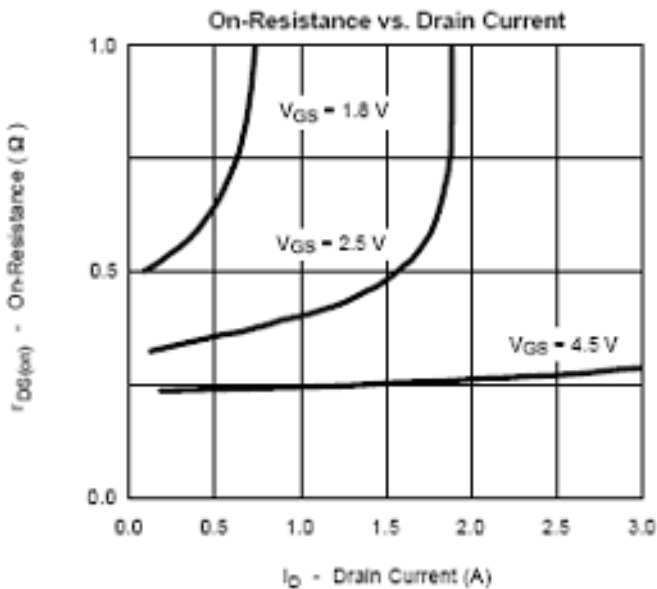
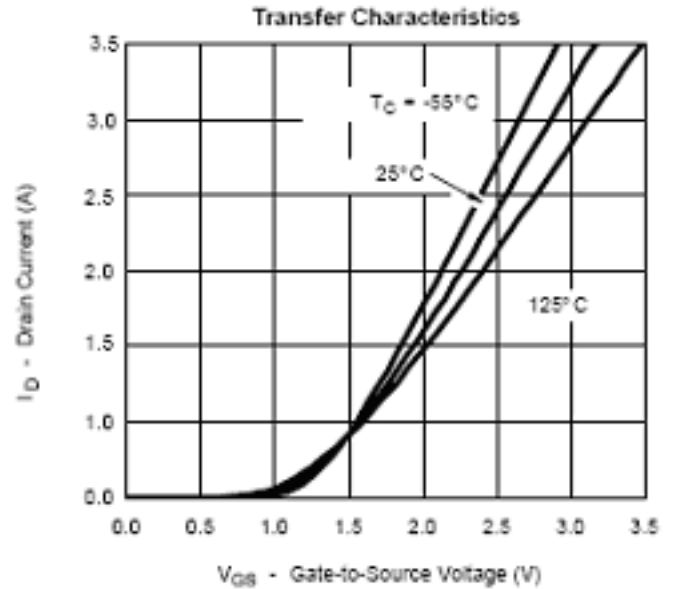
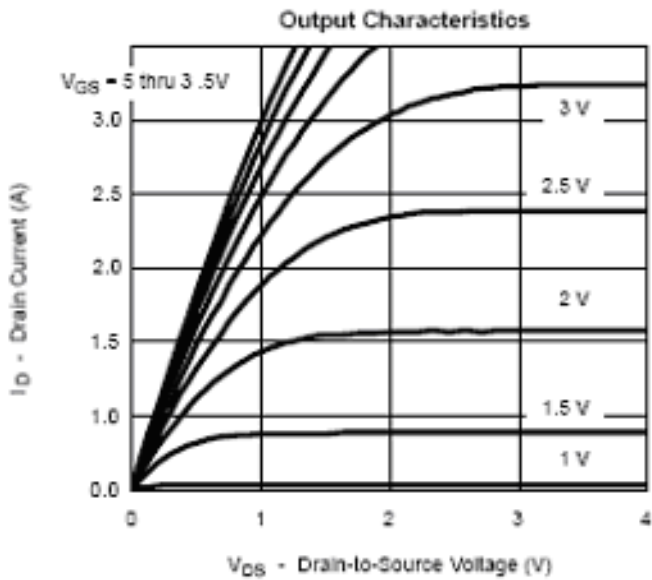



# SPP1071

## P-Channel Enhancement Mode MOSFET

### TYPICAL CHARACTERISTICS

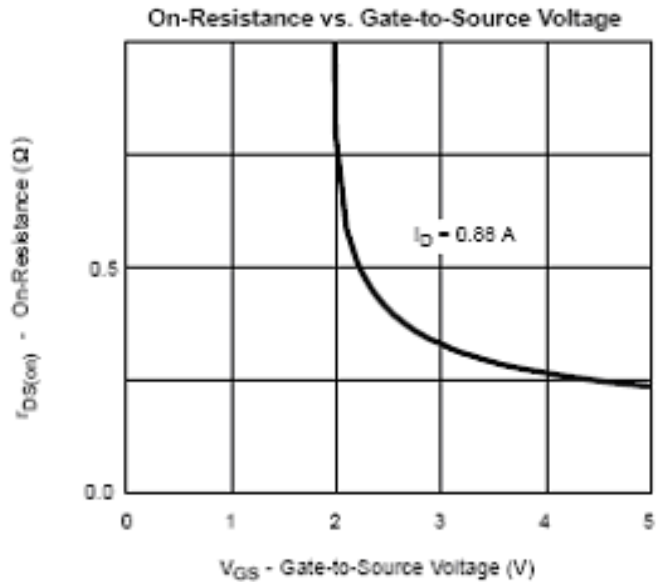
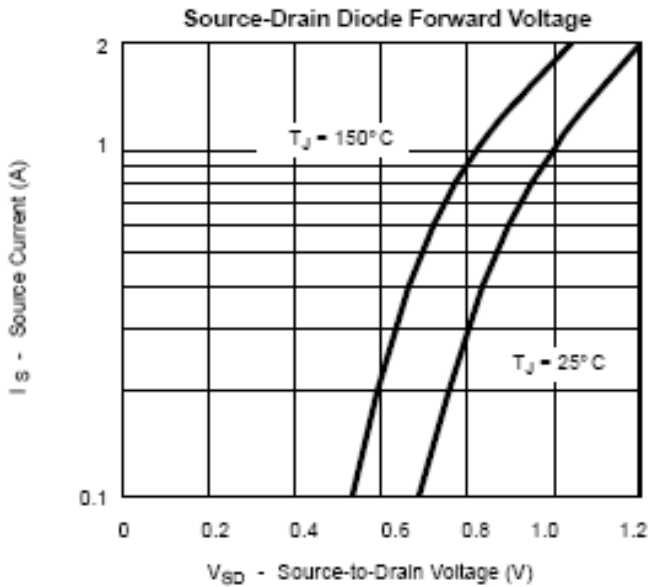
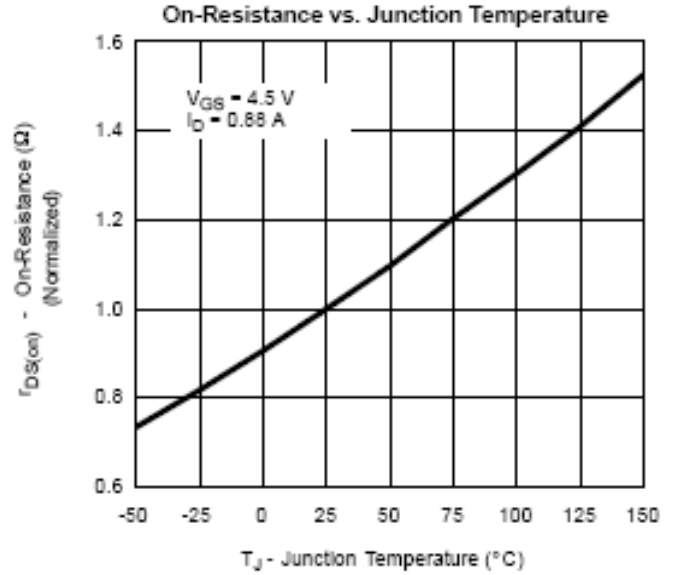
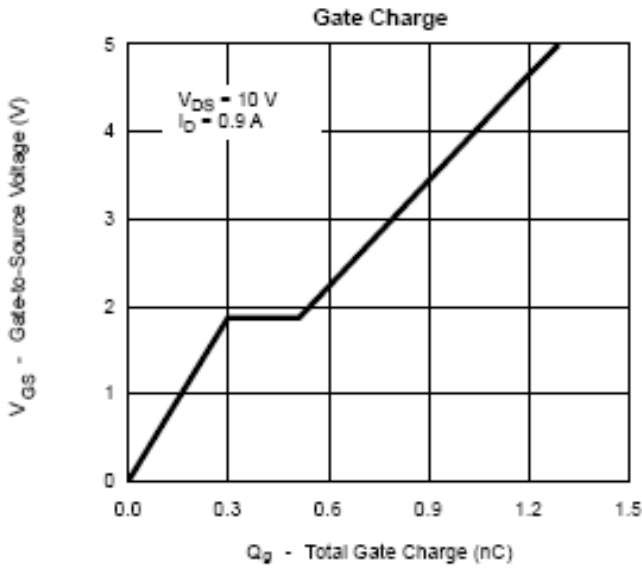



# SPP1071

## P-Channel Enhancement Mode MOSFET

### TYPICAL CHARACTERISTICS

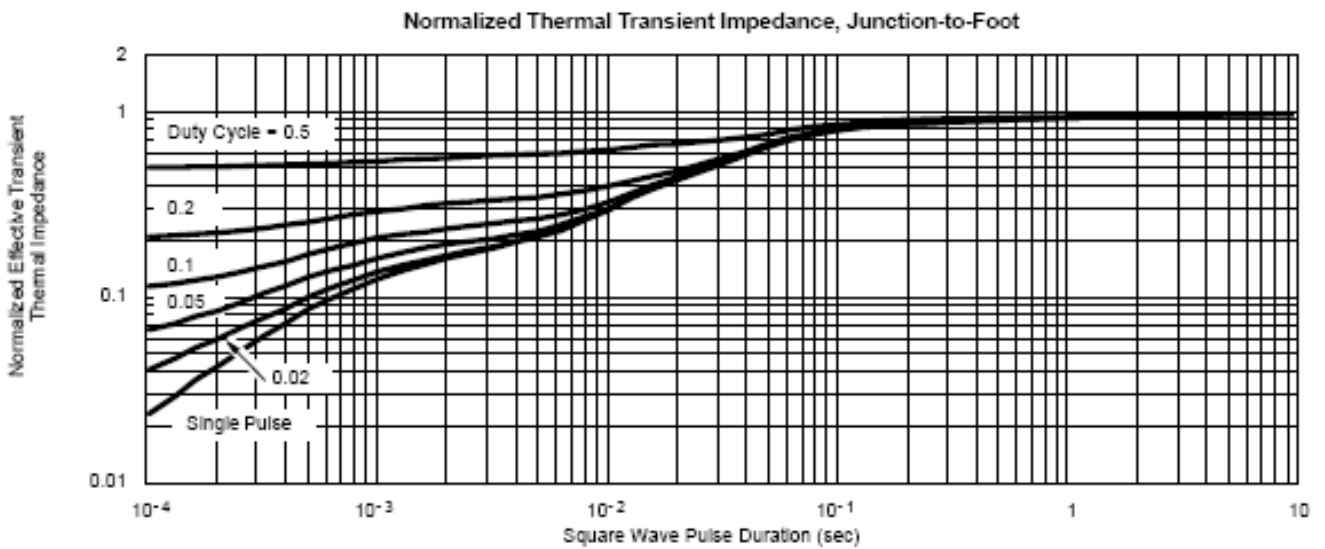
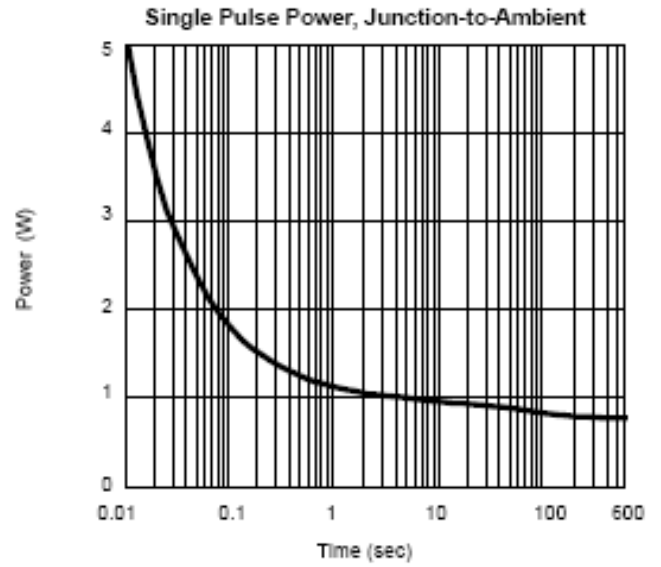
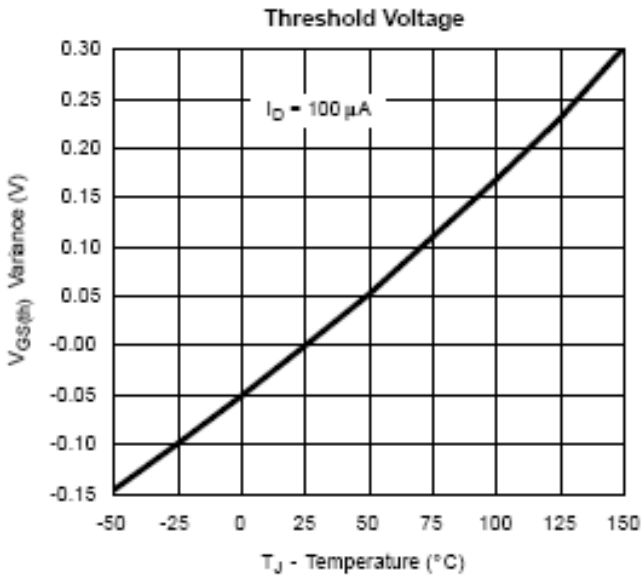



# SPP1071

## P-Channel Enhancement Mode MOSFET

### SOT-723 PACKAGE OUTLINE

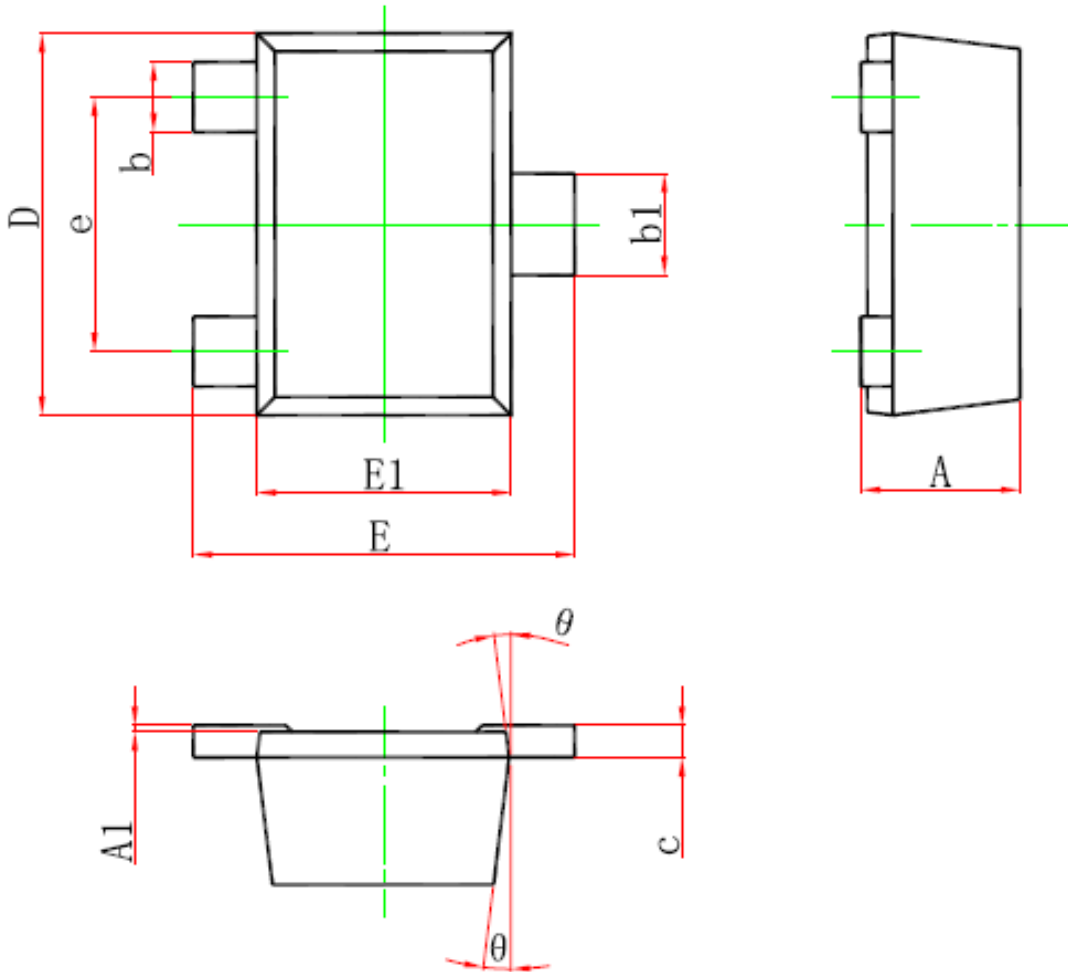

Symbol	Dimensions In Millimeters		Dimensions In Inches	
	Min.	Max.	Min.	Max.
A		0.500		0.020
A1	0.000	0.050	0.000	0.002
b	0.170	0.270	0.007	0.011
b1	0.270	0.370	0.011	0.015
c		0.150		0.006
D	1.150	1.250	0.045	0.049
E	1.150	1.250	0.045	0.049
E1	0.750	0.850	0.030	0.033
e	0.800TYP.		0.031TYP.	
θ	7° REF.		7° REF.	



# SPP1071

## P-Channel Enhancement Mode MOSFET

---

Information provided is alleged to be exact and consistent. SYNC Power Corporation presumes no responsibility for the penalties of use of such information or for any violation of patents or other rights of third parties which may result from its use. No license is granted by allegation or otherwise under any patent or patent rights of SYNC Power Corporation. Conditions mentioned in this publication are subject to change without notice. This publication surpasses and replaces all information previously supplied. SYNC Power Corporation products are not authorized for use as critical components in life support devices or systems without express written approval of SYNC Power Corporation.

© The SYNC Power logo is a registered trademark of SYNC Power Corporation

© 2018 SYNC Power Corporation – Printed in Taiwan – All Rights Reserved

SYNC Power Corporation

7F-2, No.3-1, Park Street

NanKang District (NKSP), Taipei, Taiwan 115

Phone: 886-2-2655-8178

Fax: 886-2-2655-8468

© <http://www.syncpower.com>