

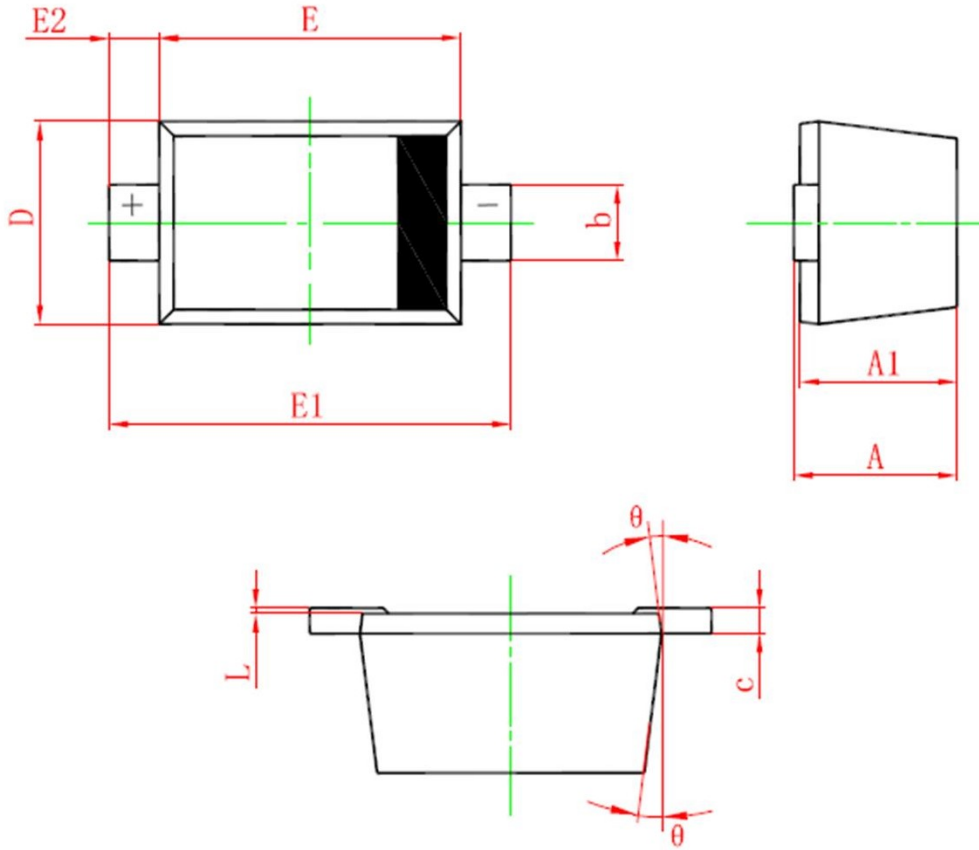

SOD-723 PACKAGE OUTLINE



SYMBOL	MIN	NOM	MAX
A	0.53	--	0.65
A1	0.52	--	0.58
b	0.25	0.30	0.35
c	0.08	0.10	0.15
D	0.55	0.60	0.65
E	0.90	1.00	1.10
E1	1.30	1.40	1.50
L	0.20REF		
L1	0.01	--	0.07
θ	7° REF		